



# **AIRPORT SERVICES MANUAL**

## **PART 1**

# **RESCUE AND FIRE FIGHTING**

**Fourth Edition — 2014**

### **NOTICE TO USERS**

This document is an unedited version of an ICAO publication and has not yet been approved in final form. As its content may still be supplemented, removed, or otherwise modified during the editing process, ICAO shall not be responsible whatsoever for any costs or liabilities incurred as a result of its use.

**Approved by the Secretary General  
and published under his authority**

**INTERNATIONAL CIVIL AVIATION ORGANIZATION**



# Part 1

## Rescue and Fire Fighting

**Fourth Edition — 2014**

### **Foreword**

In accordance with the provisions of Annex 14 — *Aerodromes*, Volume I — *Aerodrome Design and Operations*, States are required to provide rescue and firefighting equipment and services at an airport. The purpose of the material in this Manual is to assist States in the implementation of these specifications and thereby help to ensure their uniform application.

The methodology for rescue and firefighting at an aerodrome is based on the critical area concept developed by the Rescue and Fire Fighting Panel and adopted by ICAO via Amendment No. 30 to Annex 14 in 1976. The concept is based on the critical area to be protected in any post-accident fire situation with the objective of creating and maintaining survivable conditions, providing egress routes for aircraft occupants and to initiate the rescue of those occupants unable to make their escape without direct aid.

The third edition of this Manual was produced in 1990. It has been updated in 2014 as a result of a series of amendments to Annex 14, Volume I, up to and including Amendment 11. This fourth edition incorporates changes and additions resulting from an overall review by the Secretariat. Significant additions/revisions to the Manual as a result of this revision are:

- a) the introduction of the new principal extinguishing agent ie. performance level C foam (Chapter 2, updated test protocol in Chapter 8);
- b) guidance on the use of a task resource analysis in determining the minimum number of rescue and firefighting personnel (Chapter 10);
- c) updated procedures for aircraft rescue and firefighting (Chapter 12, including training in Chapter 14);
- d) guidance on preventive maintenance of vehicles and rescue equipment (Chapter 17);
- e) guidance on human factors principles in rescue and firefighting (Chapter 18);
- f) downloadable and up-to-date crash charts for commonly used aircraft by electronic linkage to aircraft manufacturers' website (Appendix 1)

The content of the Manual was developed over a period of several years with input from the Rescue and Fire Fighting Working Group of the Aerodromes Panel. The working group included aerodrome rescue and fire fighting experts, airports and pilot representative organizations and aircraft manufacturers. The manual was thereafter submitted for an extensive peer review to collect and take into account comments from the expert community. It is intended that the Manual be kept up to date. Future editions will most likely be improved on the basis of experience gained and of comments and suggestions received from users of this manual. Therefore, readers are invited to give their views, comments and suggestions on this edition. These should be directed to the Secretary General of ICAO.

## Chapter 1

### General Considerations

#### 1.1 INTRODUCTION

1.1.1 The principal objective of a RFF service is to save lives in the event of an aircraft accident or incident occurring at, or in the immediate vicinity of, an airport. The RFF service is provided to create and maintain survivable conditions, to provide egress routes for occupants and to initiate the rescue of those occupants unable to make their escape without direct aid.

1.1.2 This service must assume at all times the possibility of and need for extinguishing a fire which may:

- a) exist at the time an aircraft is landing, taking off, taxiing, parked, etc.; or
- b) occur immediately following an aircraft accident or incident; or
- c) occur at any time during rescue operations.

The rupture of fuel tanks in an aircraft crash and the consequent spillage of highly volatile fuels, and other flammable liquids used by aircraft, present a high degree of probability of ignition if these liquids come into contact with hot metal parts of the aircraft or because of sparks caused by the movement of wreckage or disturbance of the electrical circuit. Fires may also occur through the discharge of accumulated electrostatic charges at the time of ground contact or during fuelling operations. An outstanding characteristic of aircraft fires is their tendency to reach lethal intensity within a very short time. This presents a severe hazard to the lives of those directly involved and can hamper rescue or evacuation efforts.

1.1.3 For this reason, the provision of adequate and special means of dealing promptly with an aircraft accident or incident occurring at, or in the immediate vicinity of, an airport assumes primary importance because it is within this area that there are the greatest opportunities of saving lives.

1.1.4 The extent of aircraft fires which may affect rescue is influenced largely by the quantity and disposition of fuel carried by the aircraft and the location of any fuel released as a result of the accident or incident.

1.1.5 The provision of emergency exits and their ability to be opened from the inside and outside of an aircraft is of primary importance in rescue and evacuation operations. The provision of special tools to rescue crews in order to gain access to the interior of a fuselage is essential. However, their use can only be regarded as an extreme measure to be taken whenever for special reasons normal means of access including emergency exits are unavailable or unsuitable for use.

1.1.6 The most important factors bearing on effective rescue in a survivable aircraft accident is the training received, the effectiveness of the equipment and the speed with which personnel and equipment, designated for RFF purposes, can be deployed.

1.1.7 The proposals set out hereunder concerning these services are intended as a general guide, to be applied to the fullest extent practicable.

## **1.2 ADMINISTRATION**

1.2.1 The RFF service at an airport should normally be under the administrative control of the airport management, which should also be responsible for ensuring that the service provided is organized, equipped, staffed, trained and operated in such a manner as to achieve its principle objective of saving lives in the event of an aircraft accident or incident. The airport management may designate public or private organizations suitably located and equipped to provide/support the RFF service. It is intended that the fire station housing the RFF service be located on the airport and suitably located so that responses will not be delayed and ensuring response times can be met.

1.2.2 It is intended that the above include the availability of suitable specialist vehicles, rescue equipment and services for an airport located close to water, swamp, desert or other difficult environments, where a significant portion of aircraft approach or departure operations takes place over these areas. The purpose of these specialist vehicles, rescue equipment and services is to rescue aircraft occupants at an aircraft accident that may occur in these areas. Material related to rescue operations in difficult environments may be found in Chapter 13.

1.2.3 Co-ordination between the RFF service at an airport and public protective agencies (such as local fire departments, police forces, coast guard and hospitals) who may be called upon as supporting agencies should be established by prior agreement for assistance in dealing with an aircraft accident or incident. Guidance related to airport emergency planning and procedures can be found in the ICAO Airport Services Manual Part 7 Airport Emergency Planning.

1.2.4 A detailed grid map(s) of the airport and its immediate vicinity (with date of revision) should be provided for the use of the airport services concerned. Information concerning topography, access roads and location of water supplies should be indicated. This map should be conspicuously posted in the control tower and the fire station and be available on the RFF vehicles as well as other supporting vehicles required to respond to an aircraft accident or incident. Copies should also be distributed to external agencies, such as police and medical services as required. The issuing authority for the detailed grid maps should have a document control process to ensure all agencies are made aware of any changes or re-issues.

## **Chapter 2**

### **Level of Protection to be Provided**

#### **2.1 AIRPORT CATEGORY**

2.1.1 The level of protection to be provided at an airport should be based on the dimensions of the aeroplanes normally using the airport as adjusted for their frequency of operations.

2.1.2 The airport category for RFF should be based on the over-all length of the longest aeroplanes normally using the airport and their maximum fuselage width. The airport category should be determined from Table 2-1 by categorizing the aeroplanes using the airport, by first evaluating their over-all length and second, their fuselage width. If after selecting the category appropriate to an aeroplane's over-all length that aeroplane's fuselage width is greater than the maximum width in column 3 for that category, then the category for that aeroplane is actually one category higher.

**Table 2-1 AIRPORT CATEGORY FOR RESCUE AND FIRE FIGHTING**

<i>Airport category</i>	<i>Aeroplane over-all length</i>	<i>Maximum fuselage width</i>
(1)	(-2)	(3)
1	0 up to but not including 9 m	2 m
2	9 m up to but not including 12 m	2 m
3	12 m up to but not including 18 m	3 m
4	18 m up to but not including 24 m	4 m
5	24 m up to but not including 28 m	4 m
6	28 m up to but not including 39 m	5 m
7	39 m up to but not including 49 m	5 m
8	49 m up to but not including 61 m	7 m
9	61 m up to but not including 76 m	7 m
10	76 m up to but not including 90 m	8 m

2.1.3 Airports should be categorized for RFF purposes by counting the aeroplane movements in the busiest consecutive three months of the year as follows:

- a) when the number of movements of the aeroplanes in the highest category normally using the airport is 700 or greater in the busiest consecutive three months, then that category should be the airport category (see examples nos. 1 and 2); and
- b) when the number of movements of the aeroplanes in the highest category normally using the airport is less than 700 in the busiest consecutive three months, then the airport category may be one less than the highest aeroplane category (see examples nos. 3 and 4) even when there is a wide range of difference between the dimensions of the aeroplanes which are included in reaching 700 movements)-(see example no. 5).

2.1.4 It should be noted that the level of protection provided based on frequency of operations in 2.1.3 b) shall not be less than one category below the determined category.

2.1.5 Either a take-off or a landing constitutes a movement. Movements of scheduled, non-scheduled and general aviation operations should be counted in determining the airport category. A classification of representative aeroplanes by the airport category shown in Table 2-1 is included in Appendix 2.

2.1.6 The following examples illustrate the method for the determination of the airport category.

*Example No. 1*

<b>Aeroplane</b>	<b>Overall length</b>	<b>Fuselage width</b>	<b>Category</b>	<b>Movements</b>
Airbus A320	37.6 m	4.0 m	6	600
Bombardier CRJ 900	36.4 m	2.7 m	6	300
Embraer 190	36.2 m	3.0 m	6	500
ATR 72	27.2 m	2.8 m	5	200

The longest aeroplanes are categorized by evaluating, from Table 2-1, first their over-all length and second, their fuselage width, until 700 movements are reached. It may be seen that the number of movements of the longest aeroplanes in the highest category totals more than 700. The airport in this case would be category 6.

*Example No. 2*

<b>Aeroplane</b>	<b>Overall length</b>	<b>Fuselage width</b>	<b>Category</b>	<b>Movements</b>
Airbus A330-200	58.8 m	5.6 m	8	300
Boeing 787-8	56.7 m	5.8 m	8	300
Boeing 767-200	48.5 m	5.0 m	8	300

The longest aeroplanes are categorized by evaluating, from Table 2-1, first their over-all length and second, their fuselage width, until 700 movements are reached. It may be seen that the number of movements of the longest aeroplanes in the highest category totals more than 700. It may also be noted that when evaluating the category appropriate to the Boeing 767-200 aeroplane's over-length, e.g. category 7, the category selected is actually one higher as the aeroplane's fuselage width is greater than the maximum fuselage width for category 7. The airport in this case would be category 8.

*Example No. 3*

<b>Aeroplane</b>	<b>Overall length</b>	<b>Fuselage width</b>	<b>Category</b>	<b>Movements</b>
Boeing 737-900ER	42.1 m	3.8 m	7	300
Bombardier CRJ 900	36.4 m	2.7 m	6	500
Airbus A319	33.8 m	4.0 m	6	300

The longest aeroplanes are categorized by evaluating, from Table 2-1, first their over-all length and second, their fuselage width, until 700 movements are reached. It may be seen that the number of movements of the longest aeroplanes in the highest category totals only 300. The minimum category for the airport in this case would be category 6, which is one category below that of the longest aeroplane.

*Example No. 4*

<b>Aeroplane</b>	<b>Overall length</b>	<b>Fuselage width</b>	<b>Category</b>	<b>Movements</b>
Airbus A380	73.0 m	7.1 m	10	300
Boeing 747-8	76.3 m	6.5 m	10	200
Boeing 747-400	70.7 m	6.5 m	9	300

The longest aeroplanes are categorized by evaluating, from Table 2-1, first their over-all length and second, their fuselage width, until 700 movements are reached. It may be seen that the number of movements of the longest aeroplanes in the highest category totals only 500. It may also be noted that when evaluating the category appropriate to the Airbus A380 aeroplane's over-all length, e.g. category 9, the category selected is actually one higher as the aeroplane's fuselage width is greater than the maximum fuselage width for category 9. The minimum category for the airport in this case would be category 9, which is one category below that of the longest aeroplane.

*Example No. 5*

<b>Aeroplane</b>	<b>Overall length</b>	<b>Fuselage width</b>	<b>Category</b>	<b>Movements</b>
Airbus A321	44.5 m	4,0 m	7	100
Boeing 737-900ER	42.1 m	3.8 m	7	300
ATR 42	22.7 m	2.9 m	4	500

The longest aeroplanes are categorized by evaluating, from Table 2-1, first their over-all length and second, their fuselage width, until 700 movements are reached. It may be seen that the number of movements of the longest aeroplanes in the highest category totals only 400. It would appear from 2.1.3 b) above that the minimum category for the airport would be category 6 ; however, even when there is a relatively wide range of difference between the length of the longest aeroplane (Airbus A321) and the aeroplane for which the 700<sup>th</sup> movement is reached (ATR 42), the minimum category for the airport may only be reduced to category 6.

2.1.7 Notwithstanding the above, during anticipated periods of reduced activity the airport category may be reduced to that of the highest category of aeroplane planned to use the airport during that time irrespective of the number of movements.

2.1.8 *Cargo operations.* The level of protection at aerodromes used for all-cargo aeroplane operations may be reduced in accordance with Table 2-2. This is based on the need to protect only the area around the cockpit of an all-cargo aeroplane in the critical area concept. Using this rationale, the aerodrome category for all-cargo aeroplane may be reduced by providing enough water quantity  $Q_1$  for the control of fire. Information on the critical area concept and the method by which the scale of extinguishing agents has been related to the critical area may be found in 2.4.



Table 2-2. Airport category for all-cargo aeroplane

Aerodrome Category	Re-classification of aerodrome category for all-cargo aeroplanes
1	1
2	2
3	3
4	4
5	5
6	5
7	6
8	6
9	7
10	7

Note 1. - This table has been determined using the average size of aeroplane in a given category.

Note 2. - An all-cargo aeroplane is an aeroplane operated for the transportation of goods, without fare-paying passengers.

## 2.2 TYPES OF EXTINGUISHING AGENTS

2.2.1 Both principal and complementary agents should normally be provided at an airport. Principal agents produce a permanent control, i.e. for a period of several minutes or longer. Complementary agents have rapid fire suppression capability but offer a “transient” control which is usually only available during application.

2.2.2 The principal extinguishing agent should be:

- a) a foam meeting the minimum performance level A; or
- b) a foam meeting the minimum performance level B; or
- c) a foam meeting the minimum performance level C; or
- d) a combination of these agents.

The principal extinguishing agent for airports in categories 1 to 3 should preferably meet the minimum performance levels B or C foam.

2.2.3 The complementary extinguishing agent should be:

- a) dry chemical powders (classes B and C powders); or
- b) other extinguishing agents with at least the same firefighting capability.

When selecting dry chemical powder for use with foam, care must be exercised to ensure compatibility.

2.2.4 Characteristics of the recommended extinguishing agents may be found in Chapter 8.

### 2.3 AMOUNTS OF EXTINGUISHING AGENTS

2.3.1 The amounts of water for foam production and the complementary agents to be provided on the RFF vehicles should be in accordance with the airport category determined under 2.1.2 and Table 2-3, except that for airport categories 1 and 2, up to 100 per cent of the water may be substituted with complementary agent.

Table 2-3 Minimum usable amounts of extinguishing agents

Aerodrome Category	Foam meeting performance level A		Foam meeting performance level B		Foam meeting performance level C		Complementary agents	
	Water (L)	Discharge rate foam solution/minute (L)	Water (L)	Discharge rate foam solution/minute (L)	Water (L)	Discharge rate foam solution/minute (L)	Dry chemical powders (kg)	Discharge Rate (kg/second)
(1)	(2)	(3)	(4)	(5)	(6)	(7)	(8)	(9)
1	350	350	230	230	160	160	45	2.25
2	1 000	800	670	550	460	360	90	2.25
3	1 800	1 300	1 200	900	820	630	135	2.25
4	3 600	2 600	2 400	1 800	1 700	1 100	135	2.25
5	8 100	4 500	5 400	3 000	3 900	2 200	180	2.25
6	11 800	6 000	7 900	4 000	5 800	2 900	225	2.25
7	18 200	7 900	12 100	5 300	8 800	3 800	225	2.25
8	27 300	10 800	18 200	7 200	12 800	5 100	450	4.5
9	36 400	13 500	24 300	9 000	17 100	6 300	450	4.5
10	48 200	16 600	32 300	11 200	22 800	7 900	450	4.5

Note.— The quantities of water shown in columns 2, 4, and 6 are based on the average overall length of aeroplanes in a given category.

2.3.2 The amounts in Table 2-3 are the minimum amounts of extinguishing agents to be provided and are based on the average overall length of aeroplanes in a given category. If the aeroplane operating at an airport is larger than the median aeroplane, the amounts should be recalculated in accordance with paragraph 2.3.7.

2.3.3 The amounts in Table 2-3 have been determined by adding the quantity of extinguishing agents which are required to obtain a one-minute control time in the practical critical area and the quantity of extinguishing agents which are required for continued control of the fire thereafter and/or for possible complete extinguishment of the fire. Control time is the time required to reduce the initial intensity of the fire by 90 per cent. Information on the critical area concept and the method by which the scale of extinguishing agents has been related to the critical area may be found in 2.4.

2.3.4 The quantity of foam concentrate separately provided on vehicles for foam production should be in proportion to the quantity of water provided and the foam concentrate selected. The amount of foam concentrate should be sufficient to supply at least two full loads of such quantity of water where sufficient additional water supplies are immediately available to ensure a rapid replenishment of the water content carried.

2.3.5 The amounts of water specified for foam production are predicated on an application rate of 8.2 L/min/m<sup>2</sup> for a foam meeting performance level A, 5.5 L/min/m<sup>2</sup> for a foam meeting performance level B and 3.75L/min/m<sup>2</sup> for a foam meeting performance level C. These application rates are considered to be the minimum rates at which control can be achieved within one minute.

2.3.6 The amounts of foams given in Table 2-3 have been determined on the assumption that the foams meet minimum specifications approved by the State. Guidance on basic characteristics of foams is contained in Chapter 8.

2.3.7 From 1 January 2015, at aerodromes where operations by aeroplanes larger than the average size in a given category are planned, the quantities of water shall be recalculated and the amount of water for foam production and the discharge rates for foam solution shall be increased accordingly.

2.3.8 Table 2-4 provides guidance on the calculation of the quantities of water and discharge rates based on the largest overall length of aeroplane in a given category. The table is based on the use of performance level A foam with an application rate of 8.2 L/min/m<sup>2</sup>. Where performance level B or C foams are used, similar calculations should be made using the appropriate application rates. The formulae indicated in Table 2-4 is used only for the recalculation of quantities in accordance with paragraph 2.3.7.

**Table 2-4. Maximum quantities of extinguishing agents based on largest dimension of an aeroplane  
(Performance level A foam, application rate 8.2 l/min/m<sup>2</sup>)**

RFF cat.	Largest theoretical length of aeroplane, L (m)	Fuselage width, W (m)	Total width of protection area (k <sub>1</sub> + W) (m)	Theoretical Critical Area, A <sub>T</sub> = L x (k <sub>1</sub> +W)	Practical Critical Area, A <sub>P</sub> = $\frac{2}{3}$ A <sub>T</sub>	Q <sub>1</sub> = 8.2 x l x A <sub>P</sub>	Q <sub>2</sub> = k <sub>2</sub> x Q <sub>1</sub> ( see 2.4.10 for values of k <sub>2</sub> )	ΣQ = Q <sub>1</sub> +Q <sub>2</sub> (litres)	Discharge Rate (l/min) = A <sub>P</sub> x (application rate of 8.2 l/min/m <sup>2</sup> )
1	9	2	12+2 = 14	126	84	689	0, 0	689	689
2	12	2	12+2 = 14	168	112	918	0.27x918=248	1166	918
3	18	3	14+3 = 17	306	204	1673	0.30x1673=502	2175	1673
4	24	4	17+4 = 21	504	336	2755	0.58x2755=1598	4353	2755
5	28	4	30+4 = 34	952	635	5207	0.75x5207=3905	9112	5207
6	39	5	30+5 = 35	1365	910	7462	1.0x7462=7462	14924	7462
7	49	5	30+5 = 35	1715	1144	9381	1.29x9381=12,101	21482	9381
8	61	7	30+7 = 37	2257	1505	12,341	1.52x12341=18,758	31099	12341
9	76	7	30+7 = 37	2812	1876	15,383	1.70x15383=26,100	41483	15383
10	90	8	30+8 = 38	3420	2281	18,704	1.9x18704=35,538	54242	18704

2.3.9 As of 1 January 2015, at aerodromes where the level of protection is reduced in accordance with the remission factor allowed in 2.1.3 b) and where operations by aeroplanes larger than the average size in a given category are planned, the recalculation of quantities of extinguishing agents required in 2.3.7 would need to be computed based on the largest aeroplane in the reduced category. As an example, an Airbus A380 (category 10) is operating infrequently into a B747 aerodrome (category 9). If the number of movements of the A380 is less than 700 movements in the busiest consecutive three months, the aerodrome is allowed to provide a category 9 level of protection, as permitted in 2.1.3 b).

2.3.10 However, as of 1 January 2015, 2.3.7 requires the quantities of agent to be recalculated for aerodromes where operations by aeroplanes larger than the average size in a given category are planned. As the A380 is larger than the average aeroplane used for calculation of quantities of extinguishing agents for category 9 in Table 2-3, the actual quantities to be provided need to be recalculated. Since 2.1.3 b) permits a remission factor of one, the largest quantity for category 9 ie. 41,483L (for performance level A foam) should be provided. As a comparison, this quantity is more than the median quantity of 36,400L for category 9 in Table 2-3 but less than the maximum quantity of 54,242L for category 10 in Table 2-4.

2.3.11 There may be aerodromes that use more than one type of performance level foams, such as a combination of level A and B foams, which could lead to error in quantity calculation or replenishment. The use of a combination of different performance level foams at an aerodrome is therefore not encouraged.

2.3.12 For the purpose of replacing water for foam production by complementary agents, 1 kg of complementary agent shall be taken as equivalent to 1.0L of water for production of a foam meeting performance level A. Higher equivalencies for complementary agents may be used if results of tests conducted on the complementary agents used by the State have indicated higher efficiencies than those recommended above. When any other complementary agent is used, the substitution ratios need to be checked.

## **2.4 CRITICAL AREA FOR CALCULATING QUANTITIES OF WATER**

2.4.1 The critical area is a concept for rescue of the occupants of an aircraft. It differs from other concepts in that, instead of attempting to control and extinguish the entire fire, it seeks to control only that area of fire adjacent to the fuselage. The objective is to safeguard the integrity of the fuselage and maintain tolerable conditions for its occupants. The size of the controlled area required to achieve this for a specific aircraft has been determined by experimental means.

2.4.2 There is a need to distinguish between the theoretical critical area within which it may be necessary to control the fire and the practical critical area which is representative of actual aircraft accident conditions. The theoretical critical area serves only as a means for categorizing aircraft in terms of the magnitude of the potential fire hazard in which they may become involved. It is not intended to represent the average, maximum or minimum spill fire size associated with a particular aircraft. The theoretical critical area is a rectangle having as one dimension the over-all length of the aircraft and as the other dimension a length which varies with the length and width of the fuselage.

2.4.3 From experiments performed it has been established that for an aircraft with a fuselage length equal to or greater than 24 m, in wind conditions of 16 to 19 km/h and at right angles to the fuselage, the theoretical critical area extends from the fuselage to a distance of 24 m upwind and 6 m downwind. For

smaller aircraft a distance of 6 m on either side is adequate. To provide for a progressive increase in the theoretical critical area, however, a transition is used when the fuselage length is between 12 m and 24 m.

2.4.4 The over-all length of the aircraft is considered appropriate for the theoretical critical area as the entire length of aircraft must be protected from burning. If not, the fire could burn through the skin and enter the fuselage. Also, other aircraft such as T-tail aircraft often have engines or exit points in this extended portion.

2.4.5 The formula for the theoretical critical area  $A_T$  thus becomes:

<i>Over-all length</i>	<i>Theoretical critical area <math>A_T</math></i>
$L < 12 \text{ m}$	$L \times (12 \text{ m} + W)$
$12 \text{ m} \leq L < 18 \text{ m}$	$L \times (14 \text{ m} + W)$
$18 \text{ m} \leq L < 24 \text{ m}$	$L \times (17 \text{ m} + W)$
$L \geq 24 \text{ m}$	$L \times (30 \text{ m} + W)$

where  $L$  = the over-all length of the aircraft, and

$W$  = the maximum width of the aircraft fuselage.

2.4.6 As mentioned earlier, in practice it is seldom that the entire theoretical critical area is subject to fire and a smaller area, for which it is proposed to provide firefighting capacity, is referred to as the practical critical area. As a result of a statistical analysis of actual aircraft accidents, the practical critical area  $A_p$  has been found to be approximately two-thirds of the theoretical critical area, or

$$A_p = 0.667 A_T$$

2.4.7 The quantity of water for foam production can be calculated from the following formula:

$$Q = Q_1 + Q_2$$

where  $Q$  = the total water required

$Q_1$  = the water for control of the fire in the practical critical area, and

$Q_2$  = the water required after control has been established and is needed for such factors as the maintenance of control and/or extinguishment of the remaining fire.

2.4.8 The water required for control in the practical critical area ( $Q_1$ ), may be expressed by the following formula:

$$Q_1 = A \times R \times T$$

where  $A$  = the practical critical area  
 $R$  = the rate of application, and  
 $T$  = time of application.

2.4.9 The amount of water required for  $Q_2$  cannot be calculated exactly as it depends on a number of variables. The factors considered of primary importance are:

- a) maximum gross mass of the aircraft;
- b) maximum passenger capacity of the aircraft;
- c) maximum fuel load of the aircraft; and
- d) previous experience (analysis of aircraft RFF operations).

These factors, when plotted on a graph, are used to calculate the total amount of water required for each airport category. The volume of water for  $Q_2$ , as a percentage of  $Q_1$ , varies from about 0 per cent for category 1 airports to about 190 per cent for an airport category 10.

2.4.10 The graph mentioned in the preceding paragraph gives the following approximate values for aeroplanes representative of each airport category:

<i>Airport Category</i>	<i><math>Q_2 = \text{percentage of } Q_1</math> percentage</i>
1	0
2	27
3	30
4	58
5	75
6	100
7	129
8	152
9	170
10	190

## 2.5 DISCHARGE RATES

2.5.1 The discharge rates of the foam solution should not be less than the rates shown in Table 2-3. The recommended discharge rates are those required to obtain a one-minute control time on the practical critical area and have therefore been determined for each category by multiplying the practical critical area by the application rate. The discharge rate of the foam solution is thus equal to the water quantity  $Q_1$  in a control time of one minute.

2.5.2 The discharge rates of complementary agents should be no less than the rates shown in Table 2 -3.

## 2.6 SUPPLY AND STORAGE OF EXTINGUISHING AGENTS

2.6.1 The quantities of the various extinguishing agents to be provided in the RFF vehicles should be in accordance with the airport category and Table 2-3. A reserve supply of foam concentrate equivalent to 200 per cent of the quantities of these agents identified in Table 2-3 should be maintained on the airport for vehicle replenishment purposes. This will permit an immediate complete recharge of the vehicles, if necessary, subsequent to an emergency and retention of a second complete recharge should another emergency occur before airport stocks can be replenished. For the purpose of determining quantities of reserve supply, the quantities of foam concentrate carried on fire vehicles in excess of the quantity identified in Table 2-3 can be considered contributing to the reserve.

2.6.2 A reserve supply of complementary agent, equivalent to 100 per cent of the quantity identified in Table 2-3, should be maintained on the aerodrome for vehicle replenishment purposes. Sufficient propellant gas should be included to utilize this reserve complementary agent. Additionally, category 1 and 2 aerodromes that have replaced up to 100 per cent of the water with complementary agent should hold a reserve supply of complementary agent of 200 per cent.

2.6.3 Where a major delay in the replenishment of the supplies is anticipated, the amount of reserve supply in 2.6.1 and 2.6.2 should be increased as determined by, among others, the following considerations:

- a. location of RFF service (may be remote)
- b. availability of supplies
- c. delivery times
- d. customs considerations

2.6.4 Vehicle foam tanks must be kept full at all times when the vehicle is in operational service because partially filled tanks will create stability problems when the vehicle is cornering at speed. Furthermore, serious sludging problems can occur where protein foam is carried through oxidation and agitation if there is an air space above the surface of the foam. Where protein foam concentrates are used, the entire contents should be periodically discharged and the entire system washed through to ensure that the tank does not contain stale protein foam.

## 2.7 RESPONSE TIME

2.7.1 The operational objective of the RFF service should be to achieve response times of two minutes and not exceeding three minutes to the end of each runway, as well as to any other part of the movement area, in optimum conditions of visibility and surface conditions. Response time is considered to be the time between the initial call to the RFF service and the time when the first responding vehicle(s) is(are) in position to apply foam at a rate of at least 50 per cent of the discharge rate specified in Table 2-3. Determination of realistic response times should be made by RFF vehicles operating from their normal locations and not from positions adopted solely for test purposes.

2.7.2 Consideration of response times should also be given to landing and take-off areas for the exclusive use of helicopters.

2.7.3 Any other vehicles required to deliver the amounts of extinguishing agents specified in Table 2-3 should arrive in three minutes and no more than four minutes from the initial call so as to provide continuous agent application.



2.7.4 The requirements in 2.7.1 above may require an evaluation of the RFF vehicles at airports where the first responding vehicle(s) is(are) not capable of applying foams at the rate of at least 50 per cent of the recommended discharge rate for the airport category. This should be considered as an objective to be achieved as the airport vehicle fleet is upgraded.

2.7.5 To meet the operational objective as nearly as possible in times of traffic/apron congestion or in less than optimum conditions of visibility, it may be necessary to provide suitable guidance, equipment, access routes and/or procedures for RFF vehicles. These may include navigation equipment installed in the vehicles such as:

a) driver enhanced vision system (DEVIS) with on-board navigation equipment utilizing global navigation satellite system to provide the driver with the vehicle's location thus serving as an aid in navigating to the accident sites;

b) tracking using digital radio datalink to assist the vehicle driver in locating and navigating to the accident site, thereby reducing driver communications workload and improving situational awareness; and

c) low visibility enhanced vision using forward looking infrared (FLIR) device (or other comparable state-of-the-art low visibility enhanced vision technology) by sensing thermal radiation instead of visible light to improve visual awareness in smoky, foggy or dark environment.

2.7.6 In addition, other suitable provisions such as bypass access roads as well as the provision of ground movement guidance instructions by radiotelephone from air traffic control based on surveillance radar, accident site location by air traffic control and a collision avoidance facility either from equipment installed in the vehicles or provided by surveillance radar from air traffic control. For the guidance of the RFF vehicles from their station(s) or standby position(s) to the accident site, vehicles can move in a convoy and air traffic control can direct the leading vehicle(s).

## **2.8 FIRE STATION**

2.8.1 All RFF vehicles should normally be housed in a fire station. Satellite fire stations should be provided whenever the response time cannot be achieved from a single fire station.

2.8.2 The fire station should be located so that the access for RFF vehicles into the runway area is direct and clear, requiring a minimum number of turns. Details of characteristics of fire stations can be found in Chapter 9.

## **2.9 COMMUNICATION AND ALERTING SYSTEMS**

2.9.1 A discrete communication system should be provided linking a fire station with the control tower, any other fire station on the airport and the RFF vehicles.

2.9.2 An alerting system for RFF personnel should be provided at a fire station, capable of being operated from that station, any other fire station on the airport and the airport control tower.

## **2.10 NUMBER OF VEHICLES**

2.10.1 The minimum number and types of conventional RFF vehicles provided at an airport so as to

effectively deliver and deploy the agents specified for the airport category should be in accordance with Table 2-5.

**Table 2-5. Minimum number of vehicles**

<i>Airport category</i>	<i>RFF vehicles</i>
1	1
2	1
3	1
4	1
5	1
6	2
7	2
8	3
9	3
10	3

2.10.2 Details on special vehicles to be available at airports where the area to be covered by the service includes a difficult environment can be found in Chapter 13.

2.10.3 In addition to the above, suitable rescue equipment and services should be available at airports where the area to be covered by the service includes water, swamp or other difficult environments that cannot be fully served by conventional wheeled vehicles. This is particularly important where a significant portion of approach/departure operations takes place over this area. The purpose of these special vehicles is to rescue aircraft occupants at an aircraft accident that may occur in this area. Details on characteristics of these types of vehicles can be found in Chapter 5.

2.10.4 A preventive maintenance plan should be derived to ensure maximum mechanical efficiency of the RFF vehicles. In this connection, due regard should be made to the possible need to provide reserve vehicles to take the place of those which become temporarily unserviceable. Guidance on fire vehicle preventive maintenance are available in Chapter 17.

## Chapter 3

### AIRPORT FACILITIES AFFECTING RESCUE AND FIREFIGHTING SERVICES

#### 3.1 AIRPORT WATER SUPPLY

3.1.1 Supplementary water supplies, for the expeditious replenishment of RFF vehicles, should be pre-arranged. The objective of providing additional water supplies at adequate pressure and flow is to ensure rapid replenishment of aerodrome RFFS vehicles. This supports the principle of continuous application of extinguishing media to maintain survivable conditions at the scene of an aircraft accident for far longer than that provided for by the minimum amounts of water set out in Chapter 2.

3.1.2 Additional water to replenish vehicles may be required in as little as five minutes after an accident, therefore an analysis should be conducted to determine the extent to which it, and its associated storage and delivery facilities, should be provided.

3.1.3 When conducting the analysis, the following factors are amongst those items which should be considered but not limited to:

- a. Sizes and types of aircraft using the aerodrome.
- b. The capacities and discharge rates of aerodrome fire vehicles.
- c. The provision of strategically located hydrants.
- d. The provision of strategically located static water supplies.
- e. Utilisation of existing natural water supplies for firefighting purposes..
- f. Vehicle response times.
- g. Historical data of water used during aircraft accidents.
- h. The need and availability of supplementary pumping capacity.
- i. The provision of additional vehicle-borne supplies.
- j. The level of support provided by Local Authority Emergency Services.
- k. The Pre-determined Response of Local Authority Emergency Services.
- l. Fixed pumps where these may provide a rapid and less resource-intensive method of replenishment.
- m. Additional water supplies adjacent to airport fire service training areas.
- n. Overhead static water supplies.

#### 3.2 EMERGENCY ACCESS ROADS

3.2.1 Emergency access roads should be provided on an airport where terrain conditions permit their construction so as to facilitate the achievement of minimum response times. Particular attention should be given to the provision of ready access to approach areas up to 1000 m from the threshold; or at least from the threshold to the airport boundary. Where the airport is fenced, access to outside areas should be facilitated by the provision of emergency gates or frangible barriers.

3.2.2 Emergency access roads and any associated bridges should be capable of supporting the heaviest vehicles which will use them and be constructed so as to be effectively available in all weather conditions. Roads within 90 m of a runway should be constructed to prevent surface erosion and the transfer of debris

to the runway. Sufficient vertical clearance should be provided from overhead obstructions for the largest vehicles. Wherever possible, roads should permit the passage of vehicles in both directions.

3.2.3 When the surface of the road is indistinguishable from the surrounding area, or in areas where snow may obscure the location of the roads, edge markers should be placed at intervals of about 10 m.

3.2.4 Where an emergency access road, normally provided with a gate or frangible barrier, may lead emergency vehicles on to a public road the exterior face of the gate or barrier should be marked to indicate its purpose, with a prohibition of vehicle parking in its immediate vicinity. Suitably designed corners, with adequate radii for the maneuvering of major RFF vehicles, should be provided to facilitate the departure of responding vehicles through the airport fence emergency gates or barriers.

3.2.5 The combined facility of emergency access road and gate or barrier should be subject to regular inspection and physical tests where necessary to prove any mechanical element, to ensure their availability in an emergency.

3.2.6 If any gates are non-frangible and secured by other mechanical means, access through the gate(s) should be readily available, such as but not limited to, the provision of keys to the gates to be kept in the RFF vehicles.

## **Chapter 4**

### **COMMUNICATION AND ALARM REQUIREMENTS**

#### **4.1 SYSTEM FACILITIES**

4.1.1 The efficiency of a RFF service is significantly dependent on the reliability and effectiveness of its communication and alarm system. In addition, the successful conduct of the total firefighting and related rescue operation will be facilitated by the system for alerting and mobilizing other participating emergency support personnel. The importance of prompt and clear communications cannot be over-emphasized.

4.1.2 Consistent with the individual requirements of each airport there should be provision for:

- a) direct communication between air traffic control (or other activating authority provided by the airport authority) and the airport fire station(s) to ensure the prompt dispatch of RFF vehicles in the event of an aircraft emergency;
- b) communication between air traffic control and the RFF crews en route to, or in attendance at, an aircraft accident/incident. To provide guidance to the RFF vehicles during low visibility conditions, some form of navigational assistance may be required (see 2.7.5);
- c) communication between the fire station, or the main station, where more than one is provided, and the RFF vehicles;
- d) communication between the RFF vehicles, including where necessary, a system to provide inter-communication between the crew members of a RFF vehicle; and

- e) emergency alarm systems to alert auxiliary personnel and appropriate organizations located on or off the airport.

4.1.3 Additionally, a direct communication may be provided between the RFF services and the flight crew of an aircraft in emergency on the ground.

## 4.2 FIRE STATION COMMUNICATIONS

4.2.1 In considering the scope of fire station communications two important factors need to be considered. The first is the extent of the workload to be carried in the watchroom when an aircraft accident or incident occurs. The range of communication facilities will naturally be related to this workload and if some part of the emergency mobilization can be undertaken elsewhere, at the airport telephone exchange room or emergency operations centre, for example, then the fire station watchroom can be more effectively equipped and operated in its primary role. The second consideration relates to those airports operating more than one fire station. Where two or more stations are provided it is usual to designate one as the main station and its watchroom as the master watchroom, which is continuously staffed. A satellite station may also have a watchroom with fewer facilities commensurate with its subordinate role and usually staffed only until the satellite's vehicles respond to a call. In discussing fire station communications, it is essential to differentiate between the minimum requirements in main and satellite fire stations and to identify the systems which can serve both.

4.2.2 Calls to the airport fire station(s) for attendance at an aircraft accident/incident normally originate from the air traffic control. The air traffic control should be linked with the main fire station by a direct telephone line not passing through any intermediate switchboard so as to avoid delays. This line is usually provided with a distinctive buzzer in the watchroom and is safeguarded against buzzer defects by a warning light. This line can be linked to the alarm bells in the main and satellite fire station(s) so that the initiation of a call by air traffic control simultaneously alerts all personnel.

The alarm system may also be used to activate RFF vehicle room doors. A separate switch for activating the alarm bells should be provided in each fire station watchroom.

4.2.3 Fire stations should be provided with a public address system so that details of the emergency, giving location, type of aircraft involved, preferential routing for RFF vehicles, can be conveyed to crew members. Control of this system would normally be located in the master watchroom, which would also have a switch for silencing the alarm bells to avoid any interference with the effective use of the broadcast facility.

4.2.4 Some calls for emergency services may reach the main fire station from the airport telephone switchboard and it is usual to have a special telephone circuit for these priority calls. At some of these calls will be of lower priority than that associated with an aircraft accident/incident, e.g. response to fuel spills, special services, etc., it is not necessary to link this circuit with the alarm bells. The alerting and directing of these responses can be controlled from the master watchroom. A separate telephone circuit, for calls of a non-emergency nature, should also be provided in each watchroom.

4.2.5 Where the master watchroom is required to mobilize off-airport support services for aircraft-related or other emergency situations, direct telephone circuits with appropriate priority indications should be provided to the appropriate control centres.

4.2.6 Satellite fire station watchrooms should be linked to the master watchroom by a direct telephone

line. The satellite fire station should be served by the public address and alarm bell system operated by the master watchroom as well as having the ability to activate the alarm bells and make public address broadcasts within its station. A grid reference map(s) should be displayed.

4.2.7 In many instances the master fire station watchroom tends to become overloaded with alarms, switches, buzzers, coloured lights, radio equipment, public address system, etc. The watchroom should be designed in such a way as to minimize the workload on the watchroom attendant during an emergency call. The objective should be to set out the watchroom in such a manner that a call can be received and dealt with by a minimum of movement on the part of the watchroom attendant. Grid reference maps, etc., should be placed directly in front of the watchroom attendant's position. Details on design of the fire station watchroom can be found in 9.3.

4.2.8 All telephone and radio equipment in each watchroom should be regularly monitored for its service-ability and arrangements should exist for emergency repair and maintenance of this equipment. The continuity of electrical supplies to fire stations should be ensured by connexion to secondary power supplies.

### **4.3 RFF VEHICLE COMMUNICATIONS**

4.3.1 When RFF vehicles leave their fire stations and enter the manoeuvring area they come under the direction of air traffic control. These vehicles must be equipped with two-way radio communications equipment, through which their movements can at all times be subject to direction by air traffic control. The choice of a direct air traffic control/fire service frequency, monitored in the master watchroom, or a discrete airport fire service frequency, relaying air traffic control instructions and fresh information, will be a matter for the airport or appropriate authority to determine, based on local operational and technical considerations. A discrete frequency minimizes the extent to which fire service activities involve an air traffic control channel at a busy airport. It is important to provide the fire service with the facility to communicate with flight crew members in certain types of incidents, particularly where undercarriage situations are involved or aircraft evacuation may be proposed. Technical solutions are available to permit both a discrete frequency and an aircraft "talk-through" facility, subject to air traffic control approval. All transmissions should be recorded once an emergency situation has been declared.

4.3.2 The radio equipment on RFF vehicles must accommodate communication between vehicles, en route to, and in operation at, an aircraft accident. Within individual vehicles there should be an intercommunication system, particularly between drivers and monitor-operators, to optimize the deployment of the vehicles at an accident. The provision of a communication facility within an appliance must recognize the likelihood of high noise levels and this may require the use of noise-cancelling microphones, headsets and loudspeakers for effective intercommunication.

4.3.3 The RFF vehicles should be provided with communication equipment capable of communicating directly with an aircraft in a situation of emergency using an aeronautical radio frequency. The aeronautical radio frequency permits the RFF service and the aircraft to communicate with each other directly allowing the RFF crew to issue critical information regarding the exact nature of, and the hazards associated with, an emergency in progress along with recommendations for actions. Where provided, the aeronautical radio frequency may be selected by air traffic control and notified to the aircraft and the RFF service. The requirements and responsibilities for the utilization of a radio frequency between the RFF service and the flight crew of an aircraft in a situation of emergency should be detailed in a procedure agreed to between the air traffic services and the airport operator.

4.3.4 Communications between the flight crew, air traffic control and the RFF service should be maintained throughout the emergency response. Due to the critical and timely nature of the information

transmitted on this frequency, transmissions should be limited to air traffic control, pilot of the aircraft and the officer-in-charge of the RFF operations. The officer-in-charge of the RFF operations should delay transmissions to the aircraft until cleared by the air traffic control, unless the nature of the transmission is critical to emergency operations.

4.3.5 One of the prerequisites for effective communication between the RFF service and the flight crew of the aircraft is language proficiency. Steps should be taken to ensure that the rescue and fire-fighting crew, in particular the officer-in-charge of the RFF operations, demonstrates knowledge of the ICAO language designated for use in air-ground communications and ability to speak clearly so as not to adversely affect radio communication.

4.3.6 Standard Operating Procedures (SOP) explaining the use of the dedicated radio frequency be developed outlining why, when and how it should be used.

4.3.7 At the accident site the officer-in-charge of RFF operations may leave the vehicle and make observations on foot, and can then direct and inform crew members in all aspects of fire-ground operations using a portable loudhailer. This equipment may also serve a subsidiary role in communications with aircraft crew members, the occupants of the aircraft and other persons responding to the accident.

4.3.8 Rescue boats or other specialized vehicles intended for use in water, swampy areas or other difficult terrain should also be provided with two-way radio equipment. Special attention should be given to selection of units intended for use in marine applications, with their protective containment systems.

#### **4.4 OTHER COMMUNICATION AND ALERTING FACILITIES**

4.4.1 The mobilization of all parties and agencies required to respond to an aircraft emergency on a large airport will require the provision and management of a complex communications system. The requirement is examined in the *Airport Services Manual* (Doc 9137), Part 7. — *Airport Emergency Planning*, Chapter 12. That manual covers all aspects of airport emergency planning of which communications is a vital element, and which must be subject to individual consideration by airport authorities in relation to local facilities.

4.4.2 Where auxiliary personnel, not on standby duty, are required to respond to an emergency, an audible alarm (siren or air horn) should be provided which can be clearly heard in appropriate areas above normal noise level and all wind conditions. Personnel responding to alarm signals of this nature must have access to a telephone number, from which more precise information as to the nature of the emergency and their response requirement can be acquired and to appropriate transport facilities to achieve this response.

4.4.3 Direct communication between the RFF personnel and the flight crew during an emergency does not necessarily involve speech only and the possible use of hand signals, in particular at smaller airports, may be considered. Annex 2 — *Rules of the Air*, Appendix 1 contains standard emergency hand signals for emergency communication between the RFF personnel and the cockpit and/or cabin crews of the incident aircraft.

## Chapter 5

### FACTORS IN THE SPECIFICATION PROCESS FOR RESCUE AID FIREFIGHTING VEHICLES

#### 5.1 INTRODUCTION

5.1.1 Acquisition of vehicles for RFF purposes requires a detailed study of a number of factors. In this process the study will include consideration of the operational requirement, design and construction aspects and the over-all compatibility of the completed vehicle fleet with the airport's RFF support services. Figure 5-1 provides a series of typical factors which should be included in a logical progression towards a decision to acquire a new vehicle. The diagram anticipates that local knowledge of all operating conditions and experience with existing RFF vehicles will be taken into account. Each of the factors in the diagram will be examined in more detail in this chapter. The objective of every study must be to acquire vehicles which will provide an effective and reliable service throughout their "operational lives". This can only be ensured by the selection of vehicles of proven performance and reliability, to be operated by trained personnel and supported in use by programmes of preventive maintenance by qualified support personnel. A checklist of significant design, construction and performance features which should be considered in preparing a specification for a RFF vehicle is contained in 5.9.

5.1.2 It is not intended in this chapter to consider the specialized vehicles intended for use in difficult environments. These vehicles are discussed in Chapter 13. Communications equipment, which is an essential component of all RFF vehicles, is dealt within Chapter 4. The locations of the vehicles, to ensure the most effective response capability, are considered in Chapter 9, which also includes advice on the housing and technical support aspects which will preserve the functional and mechanical qualities of these vehicles.

5.1.3 In any appraisal of design and construction there are features which must be regarded as essential and, therefore, must be expressed in a specification as the minimum acceptable level of provision. Other features can be specified, above the minimum level, to facilitate operational handling, preventive maintenance or the visual appearance of a vehicle, without necessarily making a significant contribution to the effectiveness of the vehicle in its primary role. While these additional items may be desirable they will also add to the cost of the vehicle and, in some cases, to the extent and complexity of the maintenance programmes. Where, for example, the airport authority allocates a structural protection role to its RFF service, the ability to deliver water jets would be desirable. Care must be taken so that in providing this additional capability the primary role of the vehicle in aircraft firefighting is not impaired. In the following paragraphs, where appropriate, the distinction between essential and desirable features will be made. Such distinction is not intended to dismiss the value of refinements in systems, finishes or instrumentation where these are specified by the airport or appropriate authority and can be maintained in service.

5.1.4 Where, in this chapter, reference is made to a vehicle the material will also apply to the acquisition of more than one vehicle of the same design and capacity. The sole difference may lie in the procedure to be completed in the acceptance programme and in the commissioning of vehicles at the airports to which they are assigned (see 5.8.2).

5.1.5 No attempt is made in these suggestions to detail water pump capacities, pump inlet and outlet plumbing, power take-offs, foam proportioners and controls, the location of monitors (turrets) and their



operation, hose reel location, hose sizes and length and similar equipment details, although they are all items requiring careful engineering and design. Basically, such equipment is related to the extinguishing agents used, the necessary discharge rates and the manpower available and needed to place the vehicle in full operation. The over-all aim must be to provide operational simplicity, recognizing the relatively short period of time available for mounting a successful RFF operation. Where this entails a degree of engineering complexity the provision of adequate training for the staff appointed to maintain the vehicle will be essential.

## 5.2 PRELIMINARY CONSIDERATIONS

5.2.1 *Role of new vehicle.* In general terms the vehicles to be used for aircraft RFF have the characteristics as expressed in table 5-1. There are other vehicle types in use at airports, such as command vehicles, used by officers in charge of a duty watch that have virtually no rescue or firefighting capability. Some airports provide auxiliary water tank vehicles, equipped with a pump and delivery hose, to replenish foam-producing vehicles at an aircraft accident. While these can provide a useful service, particularly where there are limited installed water supplies, they cannot be described as primary vehicles. This chapter will consider only the RFF vehicles. Minimum characteristics related to these vehicles are expressed in Table 5-1. It is intended that these minimum characteristics be considered when upgrading the airport RFF vehicle fleet.

5.2.2 The original concept which created the rapid intervention vehicle was based on the then current inability of major vehicles to meet the response time specifications in 2.7.1. New technical advances in chassis design have produced RFF vehicles with greatly improved performance considered capable of providing an adequate rapid intervention at airports. The role of RFF vehicles is to reach the accident site quickly, protect evacuation paths, control any outbreak of fire and to initiate rescue. Should the dual application of principal and complementary agents be considered, the quantity of complementary agent to be carried on a vehicle may be all, or some part of that, required to by the RFF category, the disposition to be related to the number of vehicles deployed at the airport. The rescue equipment may be carried on one vehicle or distributed over the vehicles making the initial attendance to an aircraft accident.

## 5.3 QUANTITIES OF EXTINGUISHING AGENTS

5.3.1 Where vehicles are provided, as proposed in Table 2-5, they must be capable of conveying and delivering at least the minimum quantities of extinguishing agents specified in Table 2-3, according to the airport category. The response time requirements specified in 2.7.1 should also be taken into account. The vehicles may also carry some part of the rescue equipment. The selection of a vehicle of a particular capacity will be dependent on whether it is a replacement for a vehicle which is obsolete or redundant or whether it is a component of a fleet to be deployed at a new airport. In the latter case the consideration of its compatibility with existing vehicles does not arise.

5.3.2 The acquisition of a new vehicle provides an opportunity to consider not only its contribution as a replacement but also the extent to which it may be specified so as to accommodate any future RFF categorization, as may be required by changes in the volume of traffic or the introduction of longer aircraft. The anticipated "operational life" of a vehicle, with reasonable care and maintenance, will be at least ten years, and an assessment of the probable growth of traffic in this period should be a factor in the specification of a vehicle.

#### **5.4 ADVANTAGES IN ADOPTING IMPROVED EXTINGUISHING AGENTS**

A comparison of the minimum quantities of water for foam production in Table 2-3 shows the advantages to be gained by the adoption of the foam concentrates capable of performance level B or C. Additional advantages also exist in adopting either dry chemical powders or equivalent-complementary agent. In this case the advantages lie not only in a reduction in the quantity of agent to be provided but also in the improved fire suppression capabilities of these agents.

#### **5.5 COMPATIBILITY OF NEW VEHICLES WITH EXISTING FLEET**

In acquiring a new vehicle it will be natural to seek the incorporation of all improvements available from current technology. In securing these advantages it is essential to examine the extent to which they may impose new problems to personnel in the RFF and support services. In most cases the new problems are capable of resolution by additional training and the provision of appropriate support equipment. The value of a compatibility study lies in the early recognition of problem areas and the provision of solutions. As an example at the simplest level, the introduction of firefighting delivery hose, with jackets composed of synthetic materials rather than natural fibres, demands specialized repair equipment. At a more significant level, the incorporation of power-assisted control systems and electronic devices in automotive or firefighting applications is desirable since they are compact, efficient and reliable, increasing the contribution to be made by individual operatives at an aircraft accident. They will, however, require particular levels of skill in their maintenance and repair. Training will be essential to acquaint support personnel with appropriate procedures, which may include the provision of specialized tools, instruments or maintenance facilities. Wherever power-assisted controls are provided in foam production and delivery systems, a manual-override facility must also be provided to permit foam production in the event of the failure of any power-assisted function. A system for monitoring the availability of power-assisted functions, to be used as part of the vehicle's daily inspection procedure, is desirable.

#### **5.6 DIMENSIONAL OR LOADING LIMITATIONS**

5.6.1 The most obvious consideration in this context in acquiring a new RFF vehicle is whether it can be accommodated in the existing fire station. Other elements of airport design and some in the response area adjacent to the airport are important. These include the dimensions of any tunnels, archways or subways through which the vehicle may be expected to pass in responding to an emergency. Overhead cables must also be considered. Bridges, culverts and cattle-grids must be evaluated if the weight of a new vehicle is greater than that of previous types. The length and width of the vehicle will be of significance in negotiating corners and in this connection it will be important to review the ability of any new vehicle to negotiate the emergency gates provided to meet the terms of 3.2.4.

5.6.2 The design and construction of the vehicle should be suitable for carrying its full load over all types of roads and unimproved surfaces on, and in the vicinity of, the airport in all reasonable weather conditions. Detailed specifications on characteristics concerning vehicle traction and floatation cannot be issued on a blanket basis because they will vary with the terrain conditions existing or liable to exist at the individual airport at which the vehicle is in service. The off-road performance of vehicles designed for this service should be a primary consideration in the selection of the vehicle. In most cases this need makes it desirable to provide for all wheel drive with tires capable of carrying the vehicle over the unimproved ground surfaces likely to be encountered. The importance of using tires of the proper design, construction and size, so inflated and mounted to assure maximum traction and floatation, cannot be over-emphasized. Tires should be selected to provide effective performance on the terrain to be encountered in

the intended airport service. Inflation pressure should be the lowest possible consistent with the tire manufacturer's recommendations for the specific loading and service speeds of the tires selected.

## 5.7 PREPARATION OF A SPECIFICATION

5.7.1 Having reached conclusions in the preliminary stage of consideration it will be possible to produce a specification for the required vehicle. The quantities and types of extinguishing agents should be expressed at the "useable contents" levels to ensure that the containment and delivery systems are designed to take account of those quantities of each agent which cannot be discharged. Any monitor designed to discharge foam must produce a foam of the specified quality, dependent on the type of concentrate used (see Chapter 8). The output, effective range and selective patterns of discharge must be related to the requirements of the airport RFF category and to the operational tactics to be employed by the crew. Complementary agents, also discussed in Chapter 8, must be capable of delivery through monitors or extended hose lines at the defined rates of discharge, with a variable discharge capability where this would enhance their fire suppression properties. It is essential to consider the replenishment processes associated with the principal and complementary agent systems as the duration and complexity of these processes have a significant effect on vehicle availability. Where agents of all types are discharged, at accidents or in training, it is essential to return vehicles to complete availability in the shortest possible time.

5.7.2 The design of the crew compartment on any RFF vehicle can contribute to the efficiency of the vehicle in a number of ways. The first consideration is that it should be large enough to accommodate the specified crew and certain elements of equipment. The number of crew members will be determined by the total operational role to be fulfilled by the vehicle, which may anticipate activities external to the vehicle simultaneously with the discharge of extinguishing agents from the vehicle. Combined activities of this nature may be characteristic of the first responding vehicle. Other complementary agents, will normally commence their fire attack by delivering their principal agent, retaining at this stage their ability to adopt new positions to optimize their fire suppression capability. The ability to maintain uninterrupted foam production while the vehicle is in motion at speeds up to 8 km/h is an essential design feature for all vehicles. In this mode it will be impossible to deliver any complementary agent unless this is discharged through a monitor.

5.7.3 Many current vehicles are capable of operation at full capacity with one operator although some users prefer a two-members crew, consisting of a driver and a monitor-operator, which provides a more effective distribution of the operational workload. In some States larger crews are provided and it is a matter for local decision as to an appropriate crewing level, having due regard to the operational effectiveness of additional crew members while the vehicle is in motion. In all cases the crew compartment must provide for the safe conveyance of the crew to an aircraft accident with sufficient space to facilitate the donning of elements of protective clothing. The driver must have all-round visibility, effective controls and instrumentation and some form of communication with the monitor-operator during all firefighting operations. The monitor-operator must be able to assume the operating position while the vehicle is in motion and operate the monitor through at least 60° either side of the central axis of the vehicle. Depression of the monitor should deliver foam at ground level not more than 12 m ahead of the vehicle while providing an elevation of not less than 30°. Monitors should produce foam in straight streams and diffused patterns and have a high and low discharge capability. The output from the monitor should be determined in relation to the minimum output specified for the airport category in Table 2-2. In this respect it should meet or exceed the specification, if the only monitor available, or provide an appropriate element of the total requirement when more than one monitor is in use at an aircraft accident. At airports receiving aircraft over 28 m in length it is desirable to have more than one vehicle equipped with a monitor to facilitate a fire attack from more than one point.

5.7.4 Other features of crew compartment design must include ease of access or egress for crew members, adequate insulation from vibration and noise and, where appropriate, measures, including the provision of equipment, to maintain an acceptable environment in temperature extremes. The calibration of instruments and the labelling or marking of controls, switches, lockers or other locations shall be in the units and in the language specified by the airport or appropriate authority. Wherever practicable, use should be made of symbols to minimize the need for interpretation of wording or the directional application of a control. Consideration should be given to the use of status indicators, using illuminated devices to denote the availability of a facility or function or the operation of a control. These are simple to maintain and interpret and reduce the workload on drivers and monitor operators when the vehicle is in action at an accident or during training. They are preferable to analogue instrumentation unless this more complex type of equipment is required by legislation, as would be the case with a vehicle speedometer.

5.7.5 The capacity of the foam concentrate tank should be sufficient to provide the specified solution ratio for twice the capacity of the water tank. This level of provision is considered to be desirable at all airports where facilities exist for the rapid replenishment of the water tank. While rapid replenishment of the water tank may have a limited value in terms of an effective contribution at an aircraft accident it will restore the vehicle to operational readiness, eliminating the delay entailed by the problems of refilling the foam concentrate tank.

5.7.6 The requirement for bumper turrets and undertruck protection has been the subject of considerable controversy. In their early forms the two types of installation were conceived as providing protection for the vehicle during operations at an aircraft accident. Undertruck nozzles still provide this form of protection and are specified for vehicles with over 4 500 L capacity and considered optional for vehicles with up to 4 500 L capacity. Undertruck nozzles demand regular inspection to ensure their freedom from obstruction and corrosion. The term “bumper turret” defines an installation which is significantly different from the equipment fitted to earlier models of vehicles. The original forms consisted of a horizontal pipe, mounted on the front of the vehicle at a low level and delivering foam through a series of perforations. Later designs substituted the perforations for one or more fixed nozzles which delivered foam to form a protective carpet. The “bumper turret” designs, some types of which are known as “ground sweeps”, are intended to provide a dual role, not only protecting the vehicle but also offering a low-level foam application ability as a contribution to the total fire suppression capability of the vehicle. The intension is to deal with fires under wings and in areas for which the main monitor may not be entirely suitable although this task can also be undertaken with hand hose lines. Control of the discharge and direction of the “bumper turret” is usually from within the cab. It is to be noted that the provision of both “bumper turrets” and undertruck nozzles entails consumption of the principal agent which may not contribute significantly to aircraft RFF operations. It may be concluded that where these installations are specified an additional quantity of water and foam concentrate should be added to the vehicle’s capacity. The quantities in each case might be determined by including a two-minute discharge period of both installations, concurrent with the discharge of the monitor.

5.7.7 The equipment to be carried in a new vehicle will have been determined in the preliminary stage and will include some items of protective clothing for crew members, stowed near their riding positions in the crew compartment. Rescue and communications equipment must also be accommodated and the basic requirement for both is secure-stowage to preserve each item, with ready access for inspection or use. The stowage must preclude the entry of damp or dust and the retaining devices within lockers or within the crew compartment must combine security of retention with immediate release for access, a difficult combination but one for which modern design can provide acceptable solutions. To establish the scope, types and quantities of rescue equipment applicable to the range of airport categories a thorough assessment should be conducted at each location to ensure that the equipment levels maintained are commensurate with what is required. Table 5-2 provides guidance material only in relation to the range of

rescue equipment normally applicable to the airport categories. The option exists, where more than one vehicle will attend an aircraft accident, to consider the disposition of the rescue equipment to several vehicles. All RFF vehicles should be provided with searchlights or floodlights.

5.7.8 It must be appreciated that where a rescue tool requires a source of power for its operation a decision must be made as to the means of providing this source. In some cases the source can be portable, as is the situation with some pneumatic chisels, which utilize a compressed-air cylinder. Some rescue saws are operated by a small internal combustion engine, giving complete mobility but with a minor risk of introducing an ignition source in an area which may have fuel vapour concentrations. More complex rescue tools, using pneumatic, hydraulic or electrical power, require the support of equipment which can generate and maintain the power source. The two options which must then be considered are installed equipment in a vehicle or portable equipment, carried in the vehicle. In both solutions there will be a requirement for accommodation within the vehicle with the balance of operational advantage resting with portable systems. With a portable system the radius of action afforded to the rescue tools is much greater, as it is not determined by the length of the supply lines, as would be the case with equipment installed in vehicles.

5.7.9 Another form of power assisted rescue and fire-fighting equipment is now being specified by some airports. The outline of the original operational requirement is provided in 12.2.14, which identifies the problem created by fire situations in the elevated, rear-mounted engines of certain aircraft. At heights of up to 10.5 m access to the intakes of the centrally mounted engines is further complicated by the configuration of the rear fuselage. Effective delivery of an extinguishing agent from ground level or from the top of a RFF vehicle may not be achieved in all weather conditions. The technical solution may well be to provide a mechanical device to elevate the nozzle delivering the extinguishing agent, with or without an operator. Articulated or extensible devices, capable of delivering a complementary agent at an acceptable rate, are available and some have been installed on RFF vehicles.

5.7.10 Preliminary studies indicate that there may be additional operational roles for such equipment, including use as a floodlight tower to illuminate an accident site, as an observation platform, with communications equipment to report observations and as a rescue aid, permitting the opening of aircraft doors and the subsequent attachment of a form of escape slide. In considering the extent to which these apparent operational advantages may be effectively realized it is necessary to assess the frequency with which the specified situations occur. The equipment now available is effective but it imposes weight penalties, design complexity and a significant cost element in its acquisition. Certain of the functions it offers are achievable by other means and, above all, any system which anticipates the elevation of an operator, in addition to the extinguishing agent, has of necessity to be designed to ensure the safety of the operator. It is to be noted that use of these devices may pose a hazard to the vehicle. The device has to be located close to the subject aircraft, with extremely limited opportunity for rapid removal in an emergency.

5.7.11 It is also considered that in those cases where a fire has not been extinguished by the discharge of the installed system in the aircraft the use of foam streams, although not entirely effective in engine fire situations, will not add materially to the damage already sustained by the engine while preventing the development of the fire. The additional benefits, such as floodlighting and access to aircraft doors, are available by simpler means, including the use of equipment listed in Table 5-2. Statistical evidence derived from RFF interventions at aircraft accidents does not confirm a requirement for equipment of this kind. This is, however, a typical case of a desirable component for those who identify a need and can sustain the equipment in service. The training of operators, particularly drivers, will be a crucial element in any programme before introduction to operational use. The equipment must be installed in a large vehicle to provide the stable platform for its operation and this may suggest the duplication of the facility at an airport to ensure that the service remains available when one of these specialized vehicles is temporarily out of commission.

5.7.12 Automotive performance criteria for RFF vehicles are expressed at the minimum level of acceptability in Table 5-1, with other details relating to extinguishing agents and firefighting systems. In some cases, the minimum characteristics provided are less demanding than those now available from vehicle manufacturers. In particular, accelerations, top speeds and static tilt angles of completed appliances now in service exceed these specifications. In considering any proposals from manufacturers the objective would be to obtain the maximum benefits arising from technological developments, particularly where these make a contribution to safety. In this connexion stability, as demonstrated by tilt angle, and crew cab integrity would be important.

5.7.13 There are additional automotive factors to those listed in Table 5-1, including those concerned with braking performance, turning circle, tire equipment, interaxle clearance, exhaust emission and, as discussed in 5.6, dimensions. As a basic requirement these must meet or exceed national or local legislation, subject to such special dispensation as may be accorded to emergency vehicles. The provision of audible and visual devices to identify an emergency vehicle should conform to national or local legislation, in addition to any standard lighting requirement of these regulations. An additional lighting requirement for vehicles to be operated in the aircraft manoeuvring area is defined in Annex 14, Volume I, Chapter 6. Airport emergency vehicles should be finished in a conspicuous colour, preferably red, in accordance with Annex 14, Volume I, 6.2.2.2.

5.7.14 Local factors which may have effect on vehicular performance include:

- a) the altitude at which the vehicle is to operate. The performance of normally-aspirated engines may be affected at altitudes above 600 m and the use of turbochargers may be necessary to achieve acceleration and cruising speed specifications;
- b) any temperature extremes likely to be encountered by the vehicle. Very high temperatures may necessitate additional capacity in the engine cooling system. Very low temperatures may require protective equipment for the vehicle including the firefighting pump, associated plumbing and the water tank; and
- c) the presence of unusual quantities of sand or dust in the atmosphere, requiring augmented filtration in the induction system to the engine.

5.7.15 All vehicles will require regular inspection of every aspect of their structure, systems and operational functions. Servicing and preventive maintenance will ensure, as far as is practicable, that the vehicle will remain effectively available. The time taken to complete these processes will be directly related to the accessibility of all the areas to be inspected and serviced and the design of the vehicle must provide this facility. Additionally, in anticipation of the need to remove a major component, such as the engine, pump, tank or foam-making system, removable panels and suitable lifting connexions must ensure that removal and replacement does not entail unacceptable extension of down-time. One design feature, indirectly related to vehicle serviceability and the extent to which some areas will require maintenance, is the application of protective treatments and finishes. Anti-corrosion treatments are essential in most airport environments and these can be extended to protect areas which may be exposed to any deposits of foam concentrate or dry chemical agents which may be spilled during replenishment operations. The under-chassis and some elements of the superstructure can be protected against abrasion from surface material thrown up by the tires. Any steps or walkways to be used by crew members can combine non-slip characteristics with features which protect adjacent surfaces against damage by footwear. The front and sides of the vehicle, which may sustain damage when the vehicle negotiates brush, scrub or undergrowth, can be constructed of materials which can withstand this exposure, avoiding the need to regularly repaint the coachwork. This range of protective measures can prolong the availability of

a vehicle and make a significant reduction to the cost and duration of maintenance programmes.

5.7.16 For optimum foam firefighting and burn back performance the foam-making equipment should produce expansions and 25 per cent drainage times of acceptable levels. Generally, expansion ranges from 6 to 10 for film-forming or fluorine free synthetic foams and from 8 to 12 for protein based foams. Drainage time should be in excess of 3 minutes for film-forming foams and in excess of 5 minutes for protein-based foams when tested in accordance with their respective methods.

## 5.8 ADDITIONAL CONTRACTUAL CONSIDERATIONS

5.8.1 There may be a need for staff training when a new vehicle is acquired, particularly where innovations in firefighting systems, automotive components or other structural features are to be incorporated. Many constructors of RFF vehicles are able to provide such facilities in the country of construction or of use. The most valuable opportunities are those in the country of construction where training can be given as the vehicle is assembled. This can be of special benefit to personnel who will be involved in the development of preventive maintenance and periodic overhaul programmes. Visits to the sub-contractors of major components, such as the engine, transmission and fire pump, will provide invaluable professional advice, leading to a complete awareness of the total vehicle. Training of RFF personnel, particularly those with instructional duties, can also be arranged but this may be most effective in the country of use, where any special local conditions may be taken into account. This would be the case where driver training had to be provided. All training can be provided as part of the total contract for a new vehicle.

5.8.2 It is usual to include in a contract a series of tests to demonstrate the ability of a vehicle to meet a specification.

These tests may be divided into two groups — those which measure aspects of the vehicle's performance as a rescue or firefighting unit and those which measure its vehicular performance. A typical series of tests would consider:

- a) foam output, through the monitor, any side lines and the bumper turret and undertruck nozzles, where specified;
- b) the qualities of foam produced;
- c) the range and pattern of foam discharged, in both low and high levels of output, from the monitor;
- d) the operation, including the extension of any hose-line, of the complementary agent system, where specified;
- e) the conduct of replenishment procedures;
- f) the production of foam, while in motion, probably as part of a) above;
- g) the conduct of a flushing procedure on completion of foam production;
- h) acceleration and maximum speed tests;
- i) braking, turning and gradient performance tests;

- j) the weighing of the fully stowed vehicle, including separate axle weights; and
- k) static tilt test.

5.8.3 This series of tests is additional to any visual inspection of a vehicle to appraise design features, finishes, treatments and other aspects required by the specification. Where a number of identical vehicles are ordered it may be necessary to perform the tests in a) to k) above for the first production vehicle only. Acceleration and cruising speed tests should be conducted at the normal operating temperatures of the vehicle.

5.8.4 Technical manuals, describing systems, operating procedures and other construction features of the vehicle, are essential for RFF and support purposes. They can be used as instructional documents and in programming inspection and preventive maintenance procedures. Where a manual includes a list of components it can facilitate the acquisition of spare parts in precise terms. At least two copies of these technical manuals should be provided, one each for the principal officers in the RFF and maintenance services. The language in which these documents shall be presented will be for local determination.

5.8.5 Where the vehicle to be acquired has features or performance characteristics which are new to the RFF and maintenance services it may be advantageous to the airport or appropriate authority to specify a commissioning programme when the vehicle is delivered to the airport. The contractor can provide one or more representatives to introduce the vehicle to those who will be responsible for its operation and serviceability, with particular attention to drivers. Experience has shown that vehicle drivers must be given training if they are to realize the full advantages of increased power and handling qualities offered by modern vehicles. While the water and foam concentrate tanks of vehicles will normally be kept filled to capacity, drivers should be made aware of the change in handling characteristics created by partially filled tanks, which may be experienced when returning from an incident or training period.

5.8.6 Although the standards of design and construction now employed will produce vehicles which are reliable in service, subject to the introduction of reasonable handling, inspection and maintenance procedures, some unserviceability is inevitable. The repair skills available to the airport will normally ensure the early return of vehicles to operational use but there may be occasions where technical assistance will be required from the vehicle constructor. Additionally, as a preventive measure, the airport or appropriate authority may wish to secure a periodic examination of a vehicle to assess its over-all condition. To meet either of these requirements a clause can be included in the initial contract to secure these support facilities.

5.8.7 In any vehicle there are components with relatively short service "lives". These include windscreen wiper blades, fan belts, some lamps used in indicators or vehicle lighting systems and oil or air filters. These items are described as fast moving spares and a schedule of these can be discussed with the contractor prior to the delivery of the vehicle. They are usually low cost items and provision of a quantity of these as part of the initial contract will contribute to the availability of the vehicle.

5.8.8 During the "operational life" of a vehicle the failure of a major component or the consequences of a traffic accident may require the earliest provision of replacement parts additional to those held at the airport. A contract may secure an undertaking from the vehicle constructor to provide these replacements on an emergency basis, including the use of air freight facilities in appropriate cases.



## **5.9 ASPECTS TO BE CONSIDERED IN PREPARING A SPECIFICATION FOR A RFF VEHICLE**

This schedule lists some of the design, construction and performance features which should be considered in preparing a preliminary specification for a RFF vehicle. It is not intended to be fully comprehensive and it is anticipated that a more detailed specification will be developed in the negotiations with contractors who respond to the issue of the preliminary specification. This process permits the airport or appropriate authority to consider the inclusion of products and materials developed by the automotive and fire engineering industry and proposed by contractors in their submissions.

- a) Role of the vehicle to be specified (5.2.1 and 5.2.2).
- b) Extinguishing media to be carried (Chapters 2 and 8):
  - 1) principal agent:
    - quantity of water and preferred type of tank construction;
    - quantity and type of foam concentrate and preferred tank construction (5.4, 5.7.1 and 5.7.5);
    - monitor — outputs, related to dual-output monitors — ranges, patterns of delivery, monitor and monitor control locations — static and mobile foam production capability (5.7.2 and Table 5-1);
    - sideline deliveries — specify radius of action required, using hose-reel or delivery hose systems (5.7.1 and Table 5-1);
    - bumper turret — where known, state type, output, range, discharge pattern and location of controls (5.7.6 and Table 5-1);
    - undertruck protection — where known, state number and type of outlets, capacities, location of controls (5.7.6 and Table 5-1);
    - minimum foam qualities, related to type of concentrate (8.1.3 to 8.1.5);
    - replenishment facilities — water and foam concentrate (5.7.1);
    - systems flushing facilities;
    - specify any structural firefighting capability (5.1.3); and
  - 2) complementary agents:
    - type, quantity, containment and discharge requirements (8.2); and
    - replenishment facilities (5.7.1).
- c) Crew cab design requirement:
  - minimum crew capacity (5.7.2);
  - type of seating and seat belt requirement;
  - equipment stowage — state types and quantities (5.7.7);
  - access and egress considerations (5.7.4);
  - driver's visibility and control requirements (5.7.2);
  - instrumentation and controls — labeling (5.7.4);
  - communications installations — state types — specify interference suppression standard (4.3 and 5.7.2);
  - safety features — elimination of protrusions or other hazards to crew members (5.7.4)
  - noise and vibration suppression (5.7.4); and
  - need for heating or air conditioning (5.7.4).
- d) Equipment stowage:
  - list equipment to be carried, provide dimensions and weights of items, where known (5.2.2 and Table 5-2);

- state preferred locations and types of securing devices for each item (5.7.7);
  - specify type and location of emergency lighting installation and the type and location of the audible/visual emergency alarm system (5.7.7 and 5.7.13); and
  - specify type and capacity of power-source and the associated equipment to be used for powered rescue tools or extensible firefighting apparatus (5.7.8 to 5.7.11).
- e) Vehicular performance and design features:
- acceleration;
  - top speed;
  - all-wheel drive capability;
  - automatic/semi-automatic transmission
  - minimum angles of approach and departure;
  - minimum tilt angle (static);
  - single rear wheel configuration;
  - braking specification (5.7.13);
  - maximum permissible dimensions (5.6.1);
  - altitude and temperature range for operation of completed vehicle (5.7.14);
  - protective treatments or installations (5.7.14 c) and 5.7.15); and
  - vehicle lighting standards (5.7.13).
- (5.7.12 and Table 5-1)
- f) Support features:
- access to key components for inspection and maintenance purposes (5.7.15);
  - removable panels and the provision of lifting attachments for removal of major elements (tanks, pump, engine, etc.) (5.7.15);
  - requirement for engine/hours meters, automatic lubrication systems or other devices which facilitate engineering support;
  - requirement for detailed spare parts list and maintenance manuals (specify language of presentation) (5.8.4); and
  - specify types and quantities of spare parts to be included in initial purchase (5.8.7).
- g) Contractual considerations:
- specify requirement for inspections, during construction and, in full detail, before acceptance (5.8.2 and 5.8.3);
  - invite proposals for staff training (5.8.1); and
  - invite proposals for contractor's in-service support (5.8.5, 5.8.6 and 5.8.8).

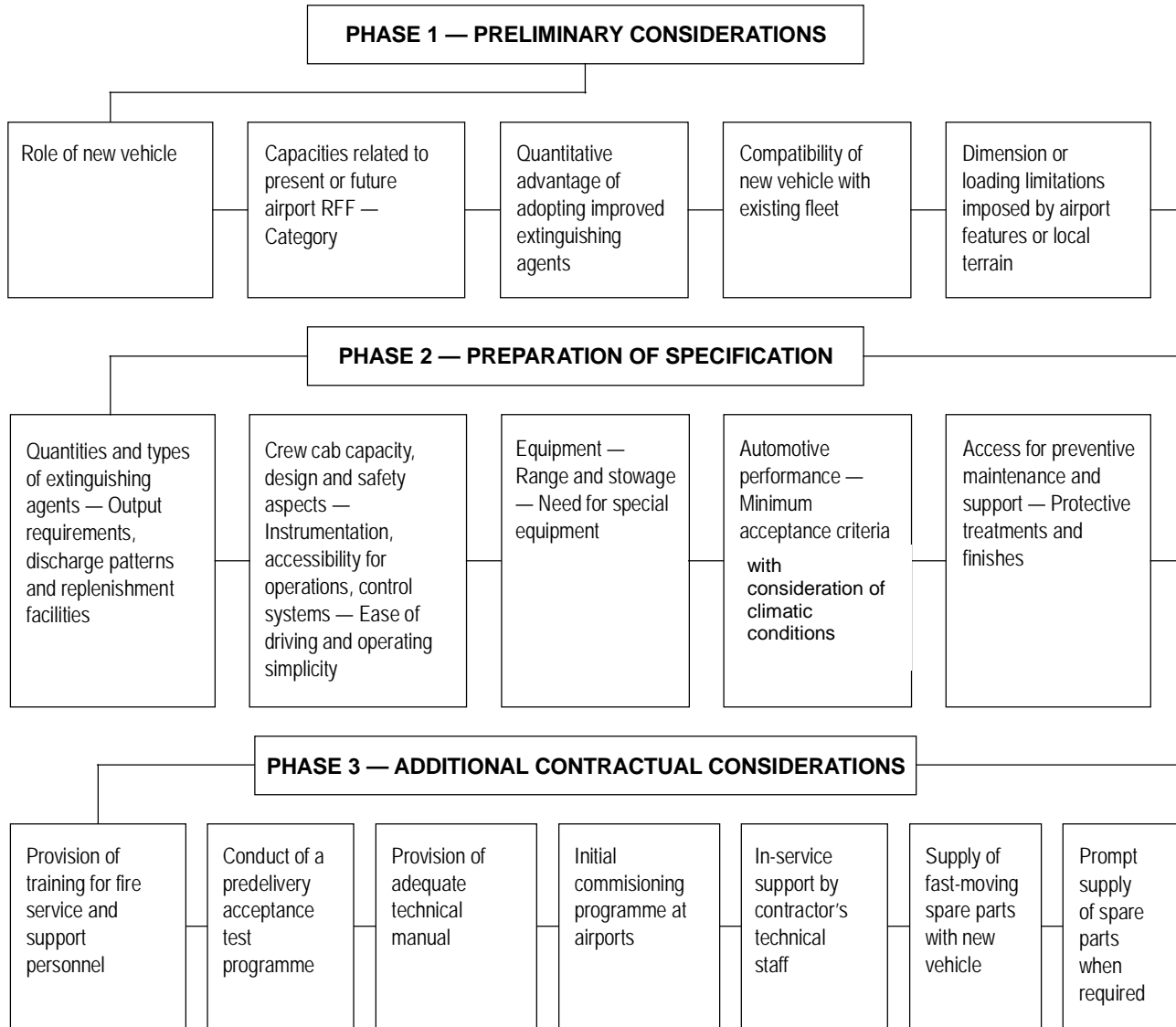

**Figure 5-1. Typical factors for selection of rescue and fire-fighting (RFF) vehicles**

**Table 5-1. Suggested minimum characteristics for RFF (RFF) vehicles**

	<i>RFF vehicles up to 4 500 L</i>	<i>RFF vehicles over 4 500 L</i>
Monitor	Optional for categories 1 and 2 Required for categories 3 to 9	Required
Design feature	High discharge capacity	High and low discharge capacity
Range	Appropriate to longest aeroplane	Appropriate to longest aeroplane
Handlines	Required	Required
Under truck nozzles	Optional	Required
Bumper turret	Optional	Optional
Acceleration	80 km/h within 25 s at the normal operating temperature	80 km/h within 40 s at the normal operating temperature
Top speed	At least 105 km/h	At least 100 km/h
All-wheel drive capability	-Required	Required
Automatic or semi-automatic transmission	Required	Required
Single rear wheel configuration	Preferable for categories 1 and 2 Required for categories 3 to 9	Required
Minimum angle of approach and departure	30°	30°
Minimum angle of tilt (static)	30°	28°

**Table 5-2. Guidance material related to rescue equipment carried on RFF vehicles**

<i>Equipment Scope</i>	<i>Equipment Item</i>	<i>Airport Category</i>			
		<b>1-2</b>	<b>3-5</b>	<b>6-7</b>	<b>8-10</b>
Forcible entry tools	Prying Tool (Hooligan, Biel type)	1	1	1	2
	Crowbar 95 cm	1	1	1	2
	Crowbar 1.65 m	1	1	1	2
	Axe, rescue large non wedge type	1	1	1	2
	Axe, rescue small non wedge or aircraft type	1	2	2	4
	Cutter Bolt 61 cm	1	1	2	2
	Hammer 1.8 kg Lump or Club type	1	1	2	2
	Chisel cold 2.5 cm	1	1	2	2
A suitable range of rescue/cut in equipment including powered rescue tools	Hydraulic/Electrical (or combination) portable rescue equipment	1	1	1	2
	Powered rescue saw complete with minimum 406mm diameter spare blades	1	1	1	2
	Reciprocating/Oscillating saw	1	1	1	2
A range of equipment for the delivery of firefighting agent	Delivery hose 30 m lengths x 50 & 64 mm diameters	6	10	16	22
	Foam Branches (Nozzles)	1	1	2	3
	Water Branches (Nozzles)	1	2	4	6
	Coupling adaptors	1	1	2	3
	Portable fire extinguishers				
		CO <sup>2</sup>	1	1	2
	DCP				
Self Contained Breathing Apparatus – <i>sufficient to maintain prolonged internal operations</i>  <i>Note: Ideally one BA set per crew member.</i>	Breathing Apparatus (BA) set c/w facemask and air cylinder				
	BA spare air cylinder				
	BA spare facemask				
Respirators	Full faced respirators c/w filters	One per responding fire fighter			
A range of ladders	Extension Ladder, Rescue & suitable for critical aircraft	-	1	2	3
	Ladder General Purpose – rescue capable	1	1	1	2
Protective clothing	Firefighting helmet, coats, over trousers (c/w	One set per operational fire			

	braces), boots & gloves as a minimum	fighter plus a % of reserve stock			
Additional items for personal protection	Protective goggles	1	1	2	3
	Flash hoods	One per operational fire fighter			
	Surgical gloves	1 box	1 box	1 box	1 box
	Blanket Fire Resisting	1	1	2	2
Rope lines	Rope Line Rescue 45 m	1	1	2	2
	Rope Line General Use 30 m	1	1	2	2
	Rope Line Pocket 6 m	One per operational fire fighter			
Communication Equipment	Portable transceivers (hand held & intrinsically safe)	1	2	2	3
	Mobile transceivers (vehicle)	One for each fire vehicle			
A range of hand held/portable lighting equipment	Hand held flashlight (intrinsically safe)	1	2	4	4
	Portable lighting – spot or flood (intrinsically safe)	1	1	2	3
A range of general hand tools	Shovel overhaul	1	1	2	2
Rescue Tool Box & contents		1	1	2	3
	Hammer, claw 0.6 kg				
	Cutters, cable 1.6 cm				
	Socket set				
	Hacksaw, heavy duty c/w spare blades				
	Wrecking bar 30 cm				
	Screwdriver set – Slotted & Phillips heads				
	Pliers, insulated Combination 20 cm Side Cutting 20 cm Slip Joint – Multi Grip 25 cm				
	Seat Belt/Harness cutting tool				
	Wrench , adjustable 30cm				
	Spanners, combination 10mm – 21 mm				
First aid equipment	Medical First Aid Kit	1	1	2	3
	Automated External Defibrillator (AED)	1	1	2	3
	Oxygen Resuscitation Equipment (ORE)	1	1	2	3
Miscellaneous equipment	Chocks & Wedges – various sizes				
	Tarpaulin - lightweight	1	1	2	3
	Thermal Imaging Camera	-	-	1	2

## Chapter 6

### PROTECTIVE CLOTHING AND RESPIRATORY EQUIPMENT

#### 6.1 PROTECTIVE CLOTHING

6.1.1 It is essential that all personnel operating at an aircraft fire be provided with protective clothing which will ensure the wearer is able to perform the assigned duties. This clothing should be provided, maintained and readily available for instant use. This specification must therefore have regard for three important factors in determining the types of clothing to be provided and the conventions specified in respect of its use during hours of duty. These are:

- a) the extent to which it is necessary to wear continuously all, or some elements of, the protective clothing so as to ensure immediate response when a call for attendance at an aircraft accident is received. Some forms of protective clothing create dressing problems which cannot easily be solved within the crew compartment of a moving vehicle;
- b) assuming that some elements of the protective clothing must be worn at all times during a tour of duty, there will be significant effects on the wearers in locations with high ambient temperatures. This is due to the nature of protective clothing and its inevitable restriction on the loss of body heat through natural ventilation processes. This suggests that there may have to be a compromise solution between the ultimate degree of protection offered by some forms of clothing and a lesser, but acceptable, form of protection which can be provided by clothing specifically designed for use in areas with high ambient temperatures. This compromise does not expose operatives to unacceptable risk but does ensure that immediate response to a call is feasible; and
- c) in all protective clothing considerations it is essential to recognize the problems which will arise for aesthetic and hygienic reasons if clothing has to be shared on an “impersonal issue” basis. The costs of protective clothing may be regarded as reasonable grounds for requiring certain elements, e.g. protective suits, to be used successively by a number of operatives in the course of a tour of duty. Apart from the practical difficulties of ensuring that each wearer is provided with clothing of the correct size in these circumstances there may well be strong personal objections to this practice. One solution is the acquisition of relatively inexpensive uniforms, some of which require a special form of undergarment for complete protection, which can be worn in part throughout hours of duty without discomfort. Adequate protection can be provided and clothing issues may then be possible on a personal basis, ensuring correct sizing and eliminating the personal difficulties described above.

6.1.2 Protective clothing is distinct from ordinary fire service uniforms and is worn during firefighting activities, including training. It is designed to provide the fire fighter with protection from radiated heat and from injuries arising from impact or abrasion during operational activities. A measure of protection from the ingress of water is also desirable particularly in low temperature operations. A typical protective uniform consists of a helmet, with visor, a suit, either in one piece or in a jacket and trousers combinations, boots and gloves. The desirable characteristics of each component are described below.

6.1.3 *Helmets.* Helmets should provide adequate protection from impact, be resistant to penetration and electrical conductivity and should not be susceptible to deformation due to heat absorption. A movable visor, resistant to abrasion, impact, and radiant heat should offer a wide angle of vision. Adequate protection to the neck and chest may also form part of the helmet if not otherwise provided by the protective suit. The helmet should not give the wearer a sense of isolation and must permit both speech and the reception of audible signals or words of command. Ideally, the helmet should be capable

of use in conjunction with respiratory protection equipment and of incorporating radiotelephone receiver installations. Where helmets incorporate radiotelephone receivers, the helmet should carry a distinctive number to identify the wearer, applied in a contrasting colour and reflective medium.

6.1.4 *Protective suits.* Protective suits can be classified into two categories, proximity suits and structural fire-fighting suits.

6.1.5 Proximity suits, designed to permit fire fighters to approach, and suppress, a fire situation, are not intended to provide the level of protection necessary for entering active fire areas. Suits with acceptable protective characteristics are provided in one piece overall designs and in two-piece jacket and trousers combinations. Materials of construction vary widely, having regard to the climatic and other considerations in the location of intended use. The comments in 6.1.1 are relevant in the selection of proximity suits by the airport or appropriate authority but there are basic criteria which should be applied before acquisition whenever proximity suits are being assessed.

- a) The suit should provide thermal insulation, must resist radiant heat and occasional direct flame contact and be water resistant. The garments should be lightweight, provide freedom of movement, be comfortable in extended periods of wear and easy to don without assistance. The fabrics employed should not be bulky and should be resistant to tearing and abrasion. They may be coated in a reflective medium or lined to minimize the effects of radiated heat on the wearer.
- b) Fastenings should be easily secured by the wearer, adequate to maintain their security under stress and resistant to damage by heat or flame contact. Seams should be waterproof and any pockets should have drainage holes in the lower corners.
- c) The entire suit should be capable of being cleaned without reducing its protective qualities. Maintenance and minor repairs should be within local capabilities and not require the return of suits to a manufacturer or distributor.

6.1.6 *Boots.* Uppers should be of a tough, flexible, heat-resistant material and extend to the mid-calf or knee level. Soles should be of a non-slip material, which may include synthetic materials, resistant to heat, oil, aircraft fuels or acids. Toe caps and soles may be reinforced with steel. The use of rubber boots in this application is not recommended.

6.1.7 *Gloves.* These should be of the gauntlet type to provide wrist protection and their construction should permit the wearer to operate switches, fastenings and hand tools. The nature of firefighting operations indicates that the back of the glove should have a reflective surface to minimize radiated heat effects and that the palm and fingers should be provided in a material resistant to abrasion and penetration by sharp objects. All seams should be resistant to penetration by liquids.

6.1.8 *Protection requirements.* As a general guide, the protective clothing, when correctly worn, should offer at least the same level of protection as a structural fire-fighting suit. The exact level of protection should be decided with regard to operational considerations and risk assessment.

Guidance relative to fire-fighting suits is available, as some examples, in the following standards:

- a) ISO 11613: Protective clothing for fire-fighters - Laboratory test methods and performance requirements;
- b) EN 469: Protective clothing for fire-fighters – Requirements and test methods for protective clothing for fire-fighting;



- c) NFPA 1971 Standard on protective clothing for structural fire-fighting; and
- d) ISO 15538:2001 Protective clothing for firefighters -- Laboratory test methods and performance requirements for protective clothing with a reflective outer surface.

## 6.2 RESPIRATORY EQUIPMENT

6.2.1 Fire fighters entering any environment in which fire is present during an aircraft incident should be protected with self contained respiratory equipment as well as during overhaul operations. This applies equally to aircraft that comprises aluminum and composite fibre materials.

6.2.2 The cabin interior of modern passenger aircraft in the main comprises synthetic materials which, during fire or charring, will produce dangerous toxic gases. Such gases include carbon monoxide, hydrogen chloride, chlorine, hydrogen cyanide and carbonyl chloride (phosgene). Fire fighters required to enter a smoke-filled cabin or other toxic environment will need self-contained respiratory equipment of an approved design for the anticipated environment.

6.2.3 Increasingly, composite fibre material is being used in the construction of modern aircraft and in particular replacing the external aluminum skin. Composite fibre, if involved in fire, can produce dangerous substances such as hydrogen cyanide, hydrogen chloride, hydrogen sulfide, hydrogen fluoride, acrolein and nitrogen dioxide. Fire fighters required to enter environments involving composite fibre that has been subject to fire will need self-contained respiratory equipment of an approved design.

6.2.4 Composite fibre, if involved in high impact such as an aircraft crash landing without the presence of fire, may become damaged to the extent minute particles of composite fibres are released to atmosphere. Fire fighters required to enter an area where minute particles of composite fibre are present will need self-contained breathing apparatus or, as a minimum, full face respirators with the appropriate filtration filters.

6.2.5 It is essential to ensure that the respiratory equipment selected is adequate in terms of its basic function, and its operational duration for the tasks involved. Industrial smoke masks and certain types of limited capacity compressed air equipment are unlikely to meet the stringent requirements of these operations.

6.2.6 It is essential to develop and maintain a high level of competence in those fire fighters appointed to wear respiratory equipment. This competence must include the most stringent procedures for the inspection, testing and maintenance of the equipment. If the highest standards are not achieved and maintained by regular training the equipment can become ineffective and present a serious hazard to the wearer.

6.2.7 Wherever self-contained respiratory equipment is operated, adequate arrangements must be made for the recharging of air cylinders with pure air and a quantity of spare parts should be held to ensure the continuous availability of the service.

## Chapter 7

### AMBULANCE AND MEDICAL SERVICES

#### 7.1 GENERAL

7.1.1 The availability of ambulance and medical services for the removal and after-care of casualties arising from an aircraft accident/incident should receive the careful consideration of airport management and should form part of the over-all emergency plan established to deal with such emergencies. Ambulances carrying personnel teams qualified in basic life support are vital to the success of initial triage in the event of an accident.

7.1.2 The extent of the facilities should have regard to the type of traffic and a reasonable estimate of the maximum number of aircraft occupants likely to be involved. The subject of airport medical services, including provisions of medical clinic and/or first aid room is given detailed consideration in the *Airport Services Manual (Doc 9137), Part 7 – Airport Emergency Planning*.

7.1.3 *Ambulances.* Any decision regarding the provision of ambulances should take into consideration the ambulance facilities available in the area of the airport and their ability to meet within a reasonable period of time a sudden demand for assistance on the scale envisaged. Regard should also be made to the suitability of such ambulances for movement on the terrain in the vicinity of the airport. The ambulance service may be part of the airport RFF service. Where it is deemed that the ambulance service provider(s) is located off the aerodrome, the aerodrome operator should promulgate in their airport emergency plan, procedures to secure the necessary commitment from such medical facilities in the event of an aircraft emergency. These procedures should take into account, factors such as proximity to the aerodrome; operating hours and capacity of the medical facilities; expected traffic situations; local terrain; and weather conditions that will affect the expeditious response and the subsequent effective delivery of medical aid. This commitment should be formalized through mutual aid emergency agreements between the aerodrome operator and the ambulance service provider(s). In the absence of such mutual aid emergency agreements, commitment by the ambulance service provider(s) can also be demonstrated by the activation, deployment and response of resources during full-scale aircraft crash exercises. On the other hand, where it is decided that the provision of an ambulance or ambulances by the appropriate authority is necessary, the following should be considered:

- a) the vehicle to be provided should be a type suitable for movement on the terrain in which it may reasonably be expected to operate and should provide adequate protection for the casualties;
- b) as a measure of economy the vehicle may be one which is used for other purposes, provided such uses will not interfere with its availability in the event of an aircraft accident. It must be suitably modified to permit the carriage of stretchers and any other necessary life-saving equipment. In a case where auxiliary personnel are relied on for firefighting and rescue purposes, the ambulance vehicle could be used for the transport of such personnel and ancillary equipment to the scene of the accident and then assume a role as an ambulance; and
- c) ambulances used to transport casualties who may have a serious communicable disease or who are contaminated with a toxic agent e.g. chemical or radioactive material, require additional consideration. Designated equipment may be necessary, and personnel involved should receive any necessary additional training and be provided with appropriate personal protective equipment.

## Chapter 8

### EXTINGUISHING AGENT CHARACTERISTICS

#### 8.1 PRINCIPAL EXTINGUISHING AGENTS

8.1.1 **Foam.** Foam used for aircraft RFF is primarily intended to provide an air-excluding blanket which prevents volatile flammable vapours from mixing with air or oxygen. To perform this function a foam must flow freely over the fuel surface, must resist disruption due to wind or exposure to heat or flame and should be capable of resealing any ruptures caused by the disturbance of an established blanket. Its water retention properties will determine its resistance to thermal exposure and will provide limited cooling to any elements of the aircraft structure to which it adheres. The quantity of foam to be produced in order to safeguard the integrity of an aircraft fuselage adjacent to a fire can be calculated using the practical critical area concept. There are several types of foam concentrate from which effective firefighting foams can be produced and these are described as follows:

a) **Protein foam.** This consists primarily of protein hydrolysate, plus stabilizing additives and inhibitors to protect against freezing, to prevent corrosion of equipment and containers, to resist bacterial decomposition, to control viscosity, and to otherwise ensure readiness for use under emergency conditions. Current formulations are used at recommended nominal concentrations of 3, 5 and 6 per cent by volume of the water discharge. All of these can be used to produce a suitable foam but the manufacturer of the foam-making equipment should be consulted as to the correct concentrate to be used in any particular system (the proportioners installed must be properly designed and/or set for the concentrate being used). Foam liquids of different types or different manufacturers should not be mixed unless it is established that they are completely interchangeable and compatible. Where a dry chemical powder is to be used as the complementary agent in conjunction with protein foam it is essential to determine the compatibility of these agents for simultaneous application. Incompatibility will result in the destruction of the foam blanket in areas where the two agents are in contact. To ensure that the tank does not contain stale protein foam, the entire contents should be discharged periodically and the entire system washed through.

b) **Aqueous Film Forming Foam (AFFF).** There are many concentrates in this category consisting basically of a fluorinated surfactant with foam stabilizer. The Concentrates may, according to the specification, be used in solutions up to 6 per cent, with appropriate proportioning systems, or in pre-mixed solutions. It is essential in selecting a concentrate to ensure that it is suitable for use in the total system incorporated in a RFF vehicle. It is also important to discuss with the manufacturer or supplier the use of an AFFF concentrate in extremes of temperature or where salt or brackish water may be used in the solution, with particular regard to any possibility of interaction between the tank structure, any surface treatment or the associated plumbing of the system. The foam produced acts to provide a barrier to exclude air or oxygen and, by the drainage of a chemically impregnated fluid from the foam, to provide a film on the fuel surface capable of containing fuel vapour. The foam produced does not have the density and visual appearance of foams produced from protein or fluoroprotein concentrates and training will be necessary to accustom fire fighters to its effectiveness as a fire suppressant. AFFF concentrates may be used in equipment normally used for protein or fluoroprotein foam production but conversion should not be undertaken without consultation with the manufacturer or supplier of the AFFF concentrate or RFF vehicle. A thorough flushing of the foam tank and the total foam-making system will be necessary before the introduction of the AFFF concentrate. Some changes in the foam-making systems of vehicles, particularly aspirating nozzles, where used, may be necessary to achieve the optimum properties of AFFF foams. The AFFF foams are compatible with all currently available dry chemical powder agents. Protein and fluoroprotein concentrates are incompatible with AFFF concentrates and they should not be mixed

although foams produced from these concentrates, separately generated, may be applied to a fire in sequence or simultaneously.

c) **Fluoroprotein foam (conventional).** This foam contains a concentration of synthetic fluorinated surfactant giving better all around performance than ordinary protein foams, as well as providing resistance to breakdown by chemical powders. Current formulations are used at concentrations of 3 and 6 per cent by volume of the water discharge. The manufacturer of the foam making equipment should be consulted as to the correct concentrate to be used in any particular system. (The proportioner used must be properly designed and/or set for the concentrate being used.) Foam liquids of different types or different manufacturer should not be mixed unless it is established that they are completely interchangeable and compatible. Compatibility of a foam produced by any proposed agent and system with a dry chemical powder agent is essential and should be established by a test programme although it is known that compatibility is a characteristic of most fluoroprotein foams.

d) **Film forming fluoroprotein (FFFP) foams.** Film forming fluoroprotein (FFFP) agents are composed of protein together with film forming fluorinated surfactants, which make them capable of forming water solution films on the surface of flammable liquids and of adding oleophobic properties to the foam generated. This characteristic makes FFFP particularly effective where the foam may be contaminated with fuel (such as forceful application). Expanded foams generated from FFFP solutions have fast spreading characteristics and act as surface barriers to exclude air and prevent vapourisation, thus suppressing combustible vapours. This film, which can spread over fuel surfaces not covered with foam, is self-sealing following mechanical disruption and continues as long as there remains a reservoir of foam for its production. To ensure extinction, however, an FFFP blanket should cover the fuel surface, as is the practice with other foams. This foam is highly effective on fuel spills because it is fluid, film forming and has oleophobic properties. Film forming fluoroprotein concentrates are available for proportioning to a final concentration of 3 to 6 per cent by volume using either fresh or sea water. They are compatible with dry chemical agents but this should be confirmed by a test programme.

e) **Synthetic foams.** This foam contains primarily petroleum products - alkylsulphates, alkylsulphanates, alkylarylsulphanates, etc. Synthetic foam forming substances also include stabilizers, anti-corrosives, and components to control viscosity, freezing temperature and bacteriological decomposition. Concentrates of different types or from different manufacturers should not be mixed in order to obtain an extinguishing foam; however, synthetic foams from different pieces of equipment are compatible and can be used one after the other or simultaneously to extinguish a fire. The degree of compatibility between synthetic foams and dry (powder) chemical substances should be determined prior to their intended use. Fluorine and organohalogen free foams complying with Level A, B and C requirements may be available under the heading of synthetic foams. These particular products are less long term damaging to the environment and are stable against polar and non-polar hydrocarbons. Fluorine and organohalogen free firefighting foams are pseudo plastic materials containing surface active agents, polymer film formers, co-surfactants, stabilisers and anti-freeze compounds. Polymer film formers prevent the destruction of finished foam. These products can be used in concentrations up to 6%, with foam compatible dry powders and with aspirating and non-aspirating equipment.

### 8.1.2 *Methods of foam production*

Foam produced by most vehicles to be used for aircraft firefighting will utilize solutions, either in premixed forms or by the use of a proportioning system, which are delivered at a predetermined pressure to nozzles. The pressure can be provided by a pump or compressed gas. There are three methods of aerating the solution:

a) **Aspiration by inducted air.** This is where a foam solution inducts air into the stream of foam solution

by the venture effect. As the foam solution passes air holes the negative pressure induces air into the stream and baffles or plates may assist the process. The optimum performing foam is dependant upon the correct ratios of foam concentrate to water and the expansion ratio achieved by the mixing action.

b) **Aspiration by compressed air insertion.** This is where compressed air (or other gas) is injected into the foam solution stream by a controlling mechanism. This is usually carried out near to the pump and proportioner and the finished foam is delivered to a branch. The optimum foam is controlled by monitoring the water flow and matching the proportion rate and compressed air.

c) **Aspiration within the jet.** This is where the foam solution is delivered non aspirated from the branch and air is entrained into the stream as it travels through the air to the fire.

In all cases the system will produce an acceptable foam only if the solution is delivered in the appropriate concentration and in the correct pressure range to the aspirating nozzle or nozzles.

8.1.3 **Quality of foams.** The quality of a foam produced by a RFF vehicle using any of the concentrate-types described in 8.1.1, will significantly affect the control and extinguishment times of an aircraft fire. Functional fire tests are required to determine the suitability of a foam concentrate in an airport environment. Paragraph 8.1.5 below lists the minimum specifications for foams produced from protein, synthetic, fluoroprotein, film forming fluoroprotein and aqueous film forming concentrates. The specifications include physical properties and the performance of the foams under fire test conditions. Any foam concentrate to be used in aircraft RFF vehicles should meet or exceed the criteria in these specifications, so as to achieve the performance level A, B or C as appropriate.

8.1.4 Where States or individual users do not have the facilities for conducting the tests, to comply with the specified properties and performances, certification of the qualification of a concentrate should be obtained from a recognized, independent and accredited third party testing authority.

8.1.5 **Foam specifications** (See Table 8-1)

**pH value.** pH value is a measurement to express the acidity or alkaline properties of a liquid. Therefore, in order to prevent the corrosion of plumbing or the foam tanks of a RFF vehicle, the foam concentrate should be as neutral as possible and should register between the values of 6 and 8.5. A foam concentrate not within these values may be acceptable to an airport RFF if the vehicle manufacturer confirms that their vehicle firefighting system is designed for higher tolerances to potential corrosion.

**Viscosity.** The viscosity of a foam concentrate. is an indication of the resistance to flow of the liquid in the plumbing of a RFF vehicle, and its consequential entry into the water system. The viscosity measurement of a foam concentrate when at its lowest temperature should not exceed 200 mm/s. Any higher registration will restrict flow and retard its adequate blending into the water stream unless special precautions are taken. The determination of viscosity for pseudo plastic liquid type foam concentrates may differ from this method, such concentrates may be utilized following a thorough proportioning test aimed at the agent can effectively be proportioned within the required tolerances using a similar RFF vehicle system.

**Sedimentation.** Sediment may form in a foam which contains impurities or if it is subjected to adverse storage, severe weather conditions and/or varying temperatures. The resultant creation of sediment may affect the performance of a vehicle's foam proportioning system or negate its firefighting efficiency. When tested by the centrifuge method, foams should contain no greater than 0.5 per cent of sediment.

### 8.1.6 *Foam Performance Acceptance Test*

It is essential that the foam produced by an RFF vehicle, or other such appliance, is of an acceptable quality and the delivery parameters such as monitor jet range and pattern meet and are maintained to the appropriate operational requirement.

In order to ensure that foam production by an RFF vehicle is of an acceptable standard a Foam Production Performance Test (i.e. an “Acceptance Test”) should be carried out:

- a) When a RFF vehicle is first acquired by the licence holder for operational use at an aerodrome. Acquisition may mean the new or second-hand purchase, leasing or hire of a RFF Vehicle.
- b) When significant maintenance, refurbishment or component replacement has been undertaken on a RFF vehicle that could affect a change in the foam quality or production performance of the foam-making system. This includes a change of foam-making branches, nozzles or monitors. Only those parts of the system that could have been affected by the work undertaken or the component change need to be tested.

The Foam Production Performance Test should confirm the following:

- a) The induction percentage for all foam-making devices. (If the foam production system is fitted with an Induction Monitoring System, the test results obtained from analysis of the foam sample should correspond with those provided with the monitoring system, i.e. check for correct calibration and accuracy of induction monitoring system.) Induction can be checked using water instead of foam.
- b) The expansion ratio from all foam making devices.
- c) The quarter drainage time from all foam making devices.
- d) The jet range of the main monitor.
- e) The spray pattern of the main monitor.

For vehicles equipped with foam monitors capable of producing foam whilst on the move, the tests shall include an assessment of this capability. Where both a high and low discharge capability has been provided on larger monitors, this provision should be tested in line with manufacturer’s guidance.

Induction systems should induce with a tolerance of +/- 10% of the desired induction percentage at optimum working conditions. Pre-mixed foam systems shall have foam concentrate introduced to within a tolerance of 1.0 to 1.1 times the manufacturer’s desired induction rate. Care should be taken in the use of freeze point depressants where pre-mixed foam systems are exposed to low temperatures, since excessive amounts of additives may have adverse effects on fire extinguishing performance. The foam performance acceptance test should be carried out as described in Section 8.1.8.

### 8.1.7 *In-Service Test*

The In-Service Test should be carried out in accordance with equipment manufacturers’ instructions:

- a) to ensure the on-going capability of the foam production system;

- b) at least every twelve months.

Once the Foam Production System has been fully tested as described in paragraph 8.1.6 and assuming no changes have been made, the In-Service Testing shall consist of periodic checks not exceeding twelve (12) months to ensure induction accuracy.

The most effective method of continually assuring the induction accuracy is for the vehicle to be fitted with a monitoring device which:

- a) monitors the induction percentage;
- b) records the dates and percentage inductions of foam concentrate;
- c) has an alert if the induction rate goes outside set parameters.

The frequency of the In-Service Tests should be determined and conducted in conjunction with the vehicle maintenance provider. The foam specimen for checking the induction percentage can be collected during normal procedural “spot” tests or training. The most common method of conducting such a test is by using a refractometer, however other methods e.g. closed loop computer controlled systems may be available.

Pre-mixed foam units shall be maintained and hydraulically pressure tested in accordance with the intervals set by manufacturer’s guidance. Only foam concentrates suitable for use in pre-mixed form shall be used in these kinds of pressure vessels.

Optimum foam firefighting and burn back performance the foam-making equipment should produce expansions and 25 per cent drainage times of acceptable levels. Generally, expansion ranges from 6 to 10 for film forming foams and from 8 to 12 for protein based foams. Drainage time should be in excess of 3 minutes for film forming foams and synthetic foams and in excess of 5 minutes for protein-based foams when tested in accordance with their respective methods.

#### 8.1.8 *Fire test method*

Objective: To evaluate the ability of a foam concentrate to:

- a) extinguish a fire of:
  - 2.8 m<sup>2</sup>, - performance Level A
  - 4.5 m<sup>2</sup>, - performance Level B
  - 7.3 m<sup>2</sup>, - performance Level C, as appropriate;
- b) resist burn back due to exposure to fuel and heat.

Equipment:

- a) A circular fire steel tray of:
  - 2.8 m<sup>2</sup> – performance Level A
  - 4.5 m<sup>2</sup> – performance Level B
  - 7.32m<sup>2</sup> – performance Level C

The vertical wall shall be 200 mm;

- b) Equipment or access to facilities to enable accurate recordings of:
  - 1) air temperature;

- 2) water temperature; and
- 3) wind velocity;

- c) Fuel:           60 L of Avtur (Jet A1) for performance level A tests;  
                  100 L of Avtur (Jet A1) for performance level B tests; and  
                  157 L of Avtur (Jet A1) for performance level C tests

*Note 1.- Avtur Jet A or kerosene with similar specifications may be used if approved by the appropriate authority.*

*Note 2.- As some aviation kerosene may contain additives, it is recommended that testing agencies utilise a pure kerosene test fuel in order to maintain and establish repeatable test results.*

- d) branch pipe, straight stream, air aspirating nozzle;
- e) suitable stop watch;
- f) circular, burn back pot, measuring 300 mm (internal diameter), 200 mm high, 2 L of gasoline or kerosene; and
- g) protective screen between tray and equipment, for protection against radiant heat, is acceptable.

Testing conditions:

- a) Air temperature (EC)  $\geq 15\text{C}$
- b) Foam solution temperature (EC)  $\geq 1.5\text{C}$
- c) Wind velocity (m/s)  $\leq 3$
- d) The test shall not be carried out in conditions of precipitation, if outdoors.



**Table 8-1**

<i>Fire Tests</i>	<i>Performance Level A</i>	<i>Performance Level B</i>	<i>Performance Level C</i>
Nozzle (Air Aspirated)			
a) Branch pipe	<i>“Uni 86” Foam nozzle (See Appendix 3)</i>	<i>“Uni 86” Foam nozzle (See Appendix 3)</i>	<i>“Uni 86” Foam nozzle (See Appendix 3)</i>
b) Nozzle pressure	700 kPa	700 kPa	700 kPa
c) Application rate	4.1 l/min/m <sup>2</sup>	2.5 l/min/m <sup>2</sup>	1.56 l/min/m <sup>2</sup>
d) Nozzle Discharge rate	11.4 l/min	11.4 l/min	11.4 l/min
Fire size	≈ 2.8 m <sup>2</sup> (circular)	≈ 4.5 m <sup>2</sup> (circular)	≈ 7.32 m <sup>2</sup> (circular)
Fuel (on water substrate)	Kerosene	Kerosene	Kerosene
Preburn time	60 s	60 s	60 s
Fire performance			
a) extinguishing time	≤ 60 s	≤ 60 s	≤ 60 s
b) total application time	120 s	120 s	120 s
c) 25% reignition time	≥ 5 min	≥ 5 min	≥ 5 min

**Test procedure**

- Position the chamber holding the premix foam upwind of the fire with the nozzle horizontal at a height of 1 m above the upper edge of the tray and at a distance that will ensure that the foam will fall into the centre of the tray.

- Test the foam apparatus to ensure:

- a) nozzle pressure; and
- b) discharge rate.

- When testing performance level A foam, place 60 L of water and 60 L of fuel into a 2.8 m<sup>2</sup> tray.

- When testing performance level B foam, place 100 L of water and 100 L of fuel into a 4.5 m<sup>2</sup> tray.

- When testing performance level C foam, place 157 L of water and 157 L of fuel into a 7.32 m<sup>2</sup> tray.

- Position the protective screen, if required.
- Test the foam apparatus to ensure a nozzle pressure of approximately 7 bar and a discharge rate of 11.4 l/min.
- Record the air, kerosene, water and foam premix temperature and check it is in the correct range.
- Record the wind velocity and check it is in the correct range.
- Ignite fuel and allow 60 seconds preburn from full involvement.

Note 1. - full involvement shall be obtained in less than 30 seconds after the beginning of ignition

Note 2. - ignition method shall forbid putting solid or liquid substance into the kerosene, for example ignition with a gas burner is acceptable.

- Apply foam continuously while maintaining the nozzle pressure and an application rate of 11.4 l/min for 120 seconds.
- Record extinction time.
- Place burn back pot in centre of fire tray.
- Ignite burn back pot 120 seconds after end of application of foam.
- Record when 25 per cent of the fuel area is re-involved with fire.

### **Firefighting performance requirements**

For each performance level, a foam concentrate is acceptable:

- a) if the time to extinguish the fire from the overall surface of the tray is equal or less than 60 seconds and;
- b) the re-ignition of 25% of the tray surface is equal or longer than 5 minutes.

Note for testing authorities: At the 60 seconds time, minute flames (flickers) visible between the foam blanket and the inner edge of the tray are acceptable:

- a) if they don't spread in a cumulative length exceeding 25% of the circumference of the inner edge of the tray and;
- b) they are totally extinguished during the second minute of foam application.

8.1.9 **Operational considerations.** The quality of foam produced by a vehicle system may be affected by the characteristics of the local water supply. It is important to acquire an adequate clear water supply. No corrosion inhibitors, freezing point depressants or other additives should be used in the water supply without prior consultation with, and the approval of, the foam concentrate manufacturer.

8.1.10 Foam can be applied to fires in two distinct forms. Solid streams are used where range of application is essential or where the stream may be deflected from a solid object to distribute it in the fire area. Solid streams must be employed with care at an aircraft accident where survivors are evacuating the aircraft and escape slides may be in use. Dispersed patterns may be employed to deliver foam at shorter

ranges to a fire area, combining greater coverage with the more effective surface application of the foam. Dispersed patterns are particularly valuable in protecting fire fighters from radiated heat. Monitors are directional control devices which deliver larger capacity streams from nozzles. Low level application allows the operator to see the position of his monitor, therefore minimising the waste of agents. In some vehicles standard water nozzles are employed to produce “fog foam”, mainly from side line deliveries. While these nozzles are effective in achieving rapid knockdown they may not be pre-calibrated to produce foams of the specified qualities and these may not have the degree of performance associated with fully-aspirated foams that normally provide a longer duration and re-ignition (burn back) protection.

8.1.11 Equipment such as High Reach Extendable Turrets (HRET) and low level High Performance Monitors can provide the operator with greater flexibility in directing the foam stream. HRET can be defined as a device, permanently mounted with a power-operated boom or booms, designed to supply a large-capacity, mobile, elevated water stream or other fire extinguishing agents, or both. The extendable turret places the nozzle well forward and below the operator, thus eliminating foam overspray and providing a clearer view of the effectiveness of agent application. The ability to position the nozzle nearer to, or in alignment with the target allows more precise aiming, reduces disruption from wind and helps to conserve agent.

8.1.12 RFF vehicles equipped with HRET may incorporate penetrating technology that provides the vehicle operator the ability to deliver extinguishment agent through an adjustable nozzle or rigid probe in and around the aircraft and into the passenger or cargo compartments. Such technology provides the ability to pierce through the fuselage or aircraft components affords the operator greater flexibility when it comes to the strategies and tactics of aircraft interior firefighting. The piercing action of the rigid tip allows agent application to the seat of the fire that may be inaccessible to hand line operations such as in the case of cargo aircraft, tail-equipped aircraft engines, and auxiliary power units (APUs).

8.1.13 Other suitable manual or hand held penetrating technologies may be include the following:

- a) manual piercing or hand held penetrating nozzles, given a safe working platform and proper protection, can deliver many of the same firefighting tactics and strategies described for HRET’s;
- b) hand held Skin Penetrating Agent Applicator Tool (SPAAT) is one of a variety of manual penetration tools available to Firefighters; and
- c) ultra-high pressure water streams have been developed using a narrow-gauge water stream to “cut” a small hole through the aircraft skin to apply agent into the interior of an aircraft. The ultra-high pressure water streams pierces the outer structure with high pressure water and aggregate enabling an exterior attack on the involved structure. Once the outer structure is penetrated, the ultra-high pressure mist into the thermal layer which cools the interior dropping temperature from 800C to 100C in a matter of seconds. This technology allows the operator to attack fire from a safe exterior position without the firefighter entering the interior of a structure.

8.1.14 The use of penetrating technology to suppress aircraft interior fires should be carefully evaluated as there are concerns regarding its efficacy and safety, in particular to passengers. Where provided, adequate training including standard operating procedures should be provided to RFF personnel involved in the use of such equipment.

## 8.2 COMPLEMENTARY AGENTS

8.2.1 Complementary agents do not generally have any substantial cooling effect on liquids or materials involved in fire. In a major fire situation extinguishment achieved by complementary agents may well only be transient and danger of “flashback” or re-ignition may occur when foam is not available to secure a fire. They are particularly effective on concealed fires (e.g. engine fires) in aircraft freight holds and beneath wings, where foams may not penetrate and on running fuel fire situations, on which foams are ineffective. They are known as complementary agents because while they may have the capability of rapid fire suppression (when applied at a sufficient rate), it is generally necessary to apply a principal agent simultaneously or at least before flashback can occur in order to achieve permanent control. Considerably improved complementary agents have become available in recent years, and constant studies are still being made in both the dry chemical and halocarbon fields.

8.2.2 Due regard must be made to the problems which may arise when large quantities of complementary agents are discharged rapidly. A dense cloud of the agent may impede aircraft evacuation or rescue operations by limiting the visibility and affecting the respiration of those exposed to the effects.

8.2.3 *Replacement of water for foam production by complementary agents.* Paragraph 2.3.1 defines conditions in which water for foam production may be replaced by complementary agents. Paragraph 2.3.11 provides the substitution ratios for each of the complementary agents in these calculations.

8.2.4 *Dry chemical powders.* These are available in a number of formulations, each consisting of finely divided chemical products which are combined with additives to improve their performance. The dry chemical powders normally provided for aircraft RFF applications are not specifically designed or intended for use on flammable metal fires, which require specialized agents (see 12.2.17). In aircraft RFF operations dry chemical powders are normally of the “BC” type, indicating their effectiveness against fires involving flammable liquids and those of an electrical origin. In addition, dry chemical powders should comply with the specifications of the International Organization for Standardization (ISO 7202). Operational applications are usually in one of the following ways:

- a) They are effective against fires in inaccessible locations and for running fuel fires, where foams are largely ineffective; and
- b) at a high rate of application in the role of a principal agent, which may well be an acceptable practice at airports with extreme climatic conditions. Details of the equivalents for the substitution of dry chemical for water for foam production may be found in 2.3.11. In addition to the problems described in 8.2.2, when large quantities of dry chemical powders are discharged rapidly limited visibility will also reduce the effective placement of foam in a dual-agent attack to those areas where the dry chemical powder has achieved “knockdown”.

8.2.5 It should be noted that dry chemical powder can be highly corrosive when applied to a metal surfaces and electrical componentry.

8.2.6 *Halogenated hydrocarbons* In line with the 1987 Montreal Protocol on Substances that Deplete the Ozone layer, the production of halon 1301, 1211 and 2402 has been banned since 1994.

8.2.6.1 The USA Environmental Protection Agency has evaluated substitutes for the ozone-depleting chemicals that are being phased out as part of its Significant New Alternatives Policy (SNAP).

8.2.6.2 Halons are therefore, no longer discussed in this document but may still be found in some aircraft fixed installations.

8.2.7 *Carbon dioxide (CO<sub>2</sub>)*. Carbon dioxide is traditionally used in aircraft RFF operations in two ways:

- a) as a means of rapid knockdown for small fires or as a flooding agent in reaching concealed fires in areas inaccessible to foam. It should not be used on fires involving flammable metals; and
- b) CO<sub>2</sub>, is most effective at high rates of delivery, achieved through “low pressure” systems.

8.2.8 CO<sub>2</sub> gas is only 1.5 times the weight of air and is therefore seriously affected in outdoor applications by the wind and the convection currents associated with a fire.

8.2.9 Carbon dioxide should comply with the specifications of the International Organization for Standardization (ISO 5923).

### 8.3 CONDITIONS OF STORAGE OF EXTINGUISHING AGENTS

8.3.1 Paragraphs 2.6.1 and 2.6.2 propose that a reserve supply of foam concentrate and complementary agents should be maintained on the airport, equivalent to 200 per cent and 100 per cent respectively of the quantity identified in Table 2-3. Paragraph 9.3.1 suggests that this reserve of agents shall be stored in the fire station(s). The conditions of storage are frequently specified by manufacturers or suppliers including the intended shelf lives but in general terms the aim should be:

a) ***Foam concentrate.*** Avoid extremes of temperature. Use stocks in order of receipt. Keep concentrate in manufacturers’ containers or a suitable on-site bulk storage facility until required for use where applicable. Where either foam concentrate drums, bladders or large above ground tanks are used they should be suitably contained in case of spill. Where more than one type of foam concentrate is in use foam concentrate containers should be suitably marked.

b) ***Dry chemical powders.*** Use stocks in order of receipt. Replace and seal the lids of any partly-used containers ensuring the powder is kept dry and free from contaminants.

## Chapter 9

### FIRE STATIONS

#### 9.1 GENERAL

In the past there has been a tendency to provide only the minimum level of accommodation for the RFF vehicles, little more than garage space, with equally sparse facilities for their crews. Experience has shown that these standards of provision are not conducive to operational efficiency in terms of either the vehicles or the personnel who are to operate them. A study of the operational requirement has emphasized the importance of correctly sited fire stations, supported by efficient communications systems, as a prerequisite for the immediate and effective response by RFF services. Properly constructed and appointed fire stations can make an important contribution to the morale and efficiency of these services. Further, response times are likely to be reduced by undertaking in the planning stage a study of traffic patterns, procedures, previous accident experience and the probable response paths of RFF vehicles. The following paragraphs discuss some of the design and site factors, which are considered to be significant in

this context.

## 9.2 LOCATION

9.2.1 The location of the airport fire station is a primary factor in ensuring that recommended response times can be achieved; that is, two minutes and not more than three minutes to the end of each runway in optimum conditions of visibility and surface conditions. Other considerations, such as the need to deal with structural fires or to undertake other duties, are of secondary importance and must be subordinated to the primary requirement. At some airports it may be necessary to consider the provision of more than one fire station, each located strategically in relation to the runway pattern. Aircraft accident studies have shown that a large proportion of accidents and incidents occur on, or close to the runway/ Accidents in or beyond runway end safety area locations often produce the more serious consequences in terms of fire situations and casualties.

9.2.2 Where more than one fire station is provided, each may contain one or more vehicles from the total fleet. This divides the over-all quantity of extinguishing agents available into units capable of initiating immediate fire suppression activities on arrival at the accident site. It is usual, with more than one fire station, to designate one as the master (or main) station, providing the master watchroom, and the other stations as satellites.

9.2.3 RFF vehicles should have direct and safe access to the movement area that caters to the size of the fire vehicle/s being deployed and be capable of reaching the extremities of this area within the recommended response time. When a new station is to be provided, vehicle response trials should be run to determine the optimum location in relation to potential accident sites. Due consideration should be given to the future development plans of the airport as these may increase the distances over which responses must be made.

9.2.4 All fire stations should be located so that access to the runway area is direct, requiring the RFF vehicles to negotiate the minimum number of turns. Additionally, the location should ensure that the vehicle running distances are as short as possible in relation to the runway(s) the fire station is intended primarily to serve. The ability to reach standby positions without delay is important. The placement of the watchroom, if provided, in each fire station should ensure the widest possible view of the movement area including aircraft approaches and departures. The installation of Closed Circuit Television (CCTV) cameras may be considered in watchrooms to enhance their view.

## 9.3 DESIGN AND CONSTRUCTION

9.3.1 Each airport fire station should be a self-contained RFF service, with appropriate facilities for the garaging of vehicles, accommodation of crew members and the provision of operational services that are necessary to ensure their continuous ability for effective and immediate response in an emergency. Facilities for the major maintenance of fire vehicles need not be included provided that these exist elsewhere, on, or in close proximity to, the airport. The range and extent of facilities may vary between those necessary in the main fire station and those appropriate to a satellite station, but in general should include:

- a) adequate accommodation for the garaging of fire vehicles, which may include other specialist vehicles such as aerial vehicles or water rescue craft and for the conduct of in-service (minor) maintenance;
- b) domestic and administrative facilities for the personnel required to operate these fire vehicles;

- c) communications and alarm systems which will ensure the immediate and effective deployment of fire vehicles in any emergency; and
- d) appropriate storage and technical support facilities as are necessary to protect and maintain the equipment and reserves of extinguishing agents held at each fire station or nearby facility.

9.3.2 In meeting these basic requirements it is desirable to consider not only design features, but also constructional details since experience has shown that inadequacies in either respect can add to the time taken to receive a call and respond to an emergency, as well as introducing problems in the day-to-day use of a fire station. Some features, which are considered to be important in ensuring the functional efficiency of fire stations, are outlined below.

9.3.3 **Vehicle housing.** This is usually provided in a series of bays, providing sufficient space for each vehicle and a surrounding area in which personnel can work conveniently. As a general rule a minimum clearance of 1.2 m should be provided around each fire vehicle. The minimum clearance area should consider and allow for the way in which fire vehicle cabin doors and locker doors open and rear mounted fire vehicle engine cowlings that may open outwards for engine access. The dimensions of each bay, including the working area, should have regard not only to the vehicles currently in service, but also to future models which may be acquired to meet increases in the airport RFF service category. The floors of the fire vehicle bays must provide for any increase in fire vehicle weights, lengths and or widths which new equipment may impose. The surface finish of floors should be resistant to oil, grease, foam concentrates, etc. and be easily cleaned. This can be achieved by having a non-slip tiled surface or a hard top sealed concrete finish. The floors should slope down towards the doors, where a transverse drain, with heavy gauge cover, can receive surface water from the bays and the forecourt. The doors to the bays must be of the quick action type and of robust design, incorporating, where possible, windows to improve the natural lighting within the bays. Bay doors may be manually operated or equipped with automatic opening devices, which may include remote operation from the watchroom or in association with the operation of the station alarm bells or alerts. Provision should be made for manual operation in the event of the malfunctioning of any automatic device. The size of the door opening must allow adequate clearance for the vehicles.

9.3.4 The forecourt should be of sufficient size to permit fire vehicles to manoeuvre and should be provided with floodlighting for night-time activities. A slope to the bay entrance drain may accommodate fire vehicle cleaning and other surface water. Within the bays there must be adequate lighting and, in appropriate cases, heating, to maintain a temperature of at least 13°C. In States where high ambient temperatures are prevalent some form of climate control should be considered. Electrical systems of appropriate design will also be required where fire vehicles are fitted with engine heaters, battery charging devices or other protective equipment. In some fire stations installations have been provided to convey exhaust fumes from each vehicle to the external atmosphere, thus avoiding contamination within the vehicle bays during periodic engine runs or rapid deployment of fire vehicles from the bays. All connections of services to fire vehicles must be designed to achieve immediate and safe disconnections without delaying the response of fire vehicles to an emergency.

9.3.5 **Domestic and administrative requirements.** Domestic facilities should include accommodation for personnel, consisting of a locker room, mess room, washroom, drying room, with consideration to administrative rooms (offices), training facilities, and fitness facilities. The locker room should provide sufficient space for the personnel to change and store their clothing as well as other personal items. Seating should also be provided. The mess room should be fitted with chairs and tables and provide facilities for the preparation of meals and food storage. Power to any cooking facilities including gas supplies should be automatically turned off on activation of the alerting systems. A drying room should

allow personnel to dry wet clothing quickly. The extent of administrative accommodation will depend on the range of technical control and administration duties to be performed in a particular fire station. The lesson room should provide tables (desks) and chairs, a magnetic whiteboard (or blackboard), as well as appropriate library facilities relevant to the functionality. Consideration may be given to electronic resources such as data viewers, screens and computers. If facilities for fitness equipment is provided the area should be well ventilated. Consideration should be given to providing fitness equipment conducive to the development and maintenance of anaerobic and aerobic fitness.

*Note: Local Building Codes and Occupational Health & Safety Legislation, or similar, may take precedence.*

**9.3.6 Support requirements.** These are facilities which can contribute to the efficiency of RFF services by preserving equipment and extinguishing media, ensuring its prompt availability and in providing test, inspection, maintenance and training opportunities. Storage space will be required for fire hoses, with suitable racking and ventilation and may include hose repair equipment and the hose record board. Drying facilities for fire hose will be required in certain climates and may be in the form of a drying tower or rack or an enclosed heating installation. Storage will be required for extinguishing media, such as foam concentrate and complimentary and particular attention must be given to ensuring that temperatures are kept within the levels specified for each agent. Suitable facilities for containment should also be provided for stored foam concentrates in the event of spillage or leak. Advice in respect of appropriate storage temperatures can be obtained from suppliers. A general workshop, where maintenance and repairs can be performed, will make a valuable contribution towards the efficient and economical operation of the service. Ideally, a fire station should be provided with a hydrant capable of delivering water at an appropriate rate to minimize replenishment times. Appropriate facilities for the testing of fire hose and vehicles, for the rapid replenishment of vehicles after use and for training purposes should be readily available. Pumping facilities for transferring foam concentrates from containers to fire vehicles expeditiously is also desirable. Facilities for the expeditious replenishment of complimentary agent for fire vehicles are also desirable.

**9.3.7 Watchrooms.** In all fire stations there must be a central point for the reception of emergency calls, from which fire vehicles may be dispatched for responses of all kinds and resources can be mobilized and directed. This should be in the form of a watchroom, which should be sited in a position which overlooks as much of the movement area as possible. It may be necessary to elevate the watchroom to provide the maximum degree of surveillance. Special provisions may be necessary to soundproof the watchroom and to deal with the consequent ventilation and climate control problems which sound proofing may create. Tinted windows or sunshades may be required in some locations to minimize the effects of direct or indirect exposure to the sun and other external elements such as concrete surfaces and climatic conditions. Provision will be necessary to vary the intensity of watchroom lighting to permit external vision when the watchroom is in use at night. The communications facilities required in watchrooms are discussed in 4.2, where a distinction is made between the requirements for the master watchroom and watchrooms in satellite fire stations.

**9.3.8 General aspects.** In addition to the particular requirements considered above there are a number of general items, applicable to all fire stations, which can contribute to their efficient operation and the well-being of personnel. Except where it may be necessary to elevate a watchroom for operational reasons, it is desirable to provide all accommodation on one level. It is important, in preparing the original plan, to make some provision for expansion to correspond with the growth of the airport. If the plan meets this situation by providing the domestic accommodation to one side of the vehicle bays, an additional benefit will be the exclusion of exhaust fumes from this accommodation when the vehicles are run up. Fire vehicle bays with access from the rear will aid the movement of fire vehicles by providing a drive-through facility. The parking of fire vehicles should be such that the failure of any one should not prevent



others from making an immediate response. The high noise levels to which some fire stations may be exposed may require some measure of sound proofing in the domestic accommodation in addition to the watchroom. Additional attention to ventilation and climate control may also become necessary in ensuring the comfort and efficiency of the occupants. All fire stations should be connected to a secondary (standby) electrical power supply to ensure the continuous availability of essential equipment and facilities.

## **Chapter 10**

### **PERSONNEL**

#### **10.1 GENERAL REQUIREMENTS**

10.1.1 The total number of personnel, whether regular or auxiliary, required to deploy and operate the RFF service should be determined so as to meet the following criteria:

- a) the RFF vehicles should be staffed so as to ensure their ability to discharge at their maximum designed capability extinguishing agents, principal or complementary, both effectively and simultaneously, at an aircraft accident/incident; and
- b) any control room or communications facility operated by, and serving, the RFF service can continue to provide this service until alternative arrangements to undertake this function are initiated by the airport emergency plan.

10.1.2 In addition, in determining the minimum number of RFF personnel required, a task resource analysis (see 10.5) should be completed and the level of staffing documented in the Aerodromes Manual. During flight operations sufficient trained and competent personnel should be designated to be readily available to ride the RFF vehicles and to operate the equipment at maximum capacity. These personnel should be deployed in a way that ensures that minimum response times can be achieved and that continuous agent application at the appropriate rate can be fully maintained. Consideration should also be given for personnel to use hand lines, ladders and other RFF equipment normally associated with aircraft RFF operations. The responding vehicles should provide at least the minimum discharge rates specified in the tables. The remainder of the vehicles may be staffed by personnel not necessarily employed in close proximity to their vehicles but able to respond when the alarm sounds so as to reach the scene of the accident no more than one minute after the first responding vehicle(s) so as to provide continuous foam application.

10.1.3 All personnel (regular and/or auxiliary) provided for aircraft RFF duties, should be fully trained in the performance of their duties and under the direction of a designated chief of emergency crew. Selected personnel should receive special driving instruction in cross-country and soft-ground techniques. (See also Chapter 14.) Where the response area of the RFF service includes water, swamps or other difficult terrain and suitable rescue equipment and procedures are provided for these locations, the personnel designated to respond should be adequately trained and exercised to provide a prompt and effective service.

## 10.2 SELECTION OF PERSONNEL FOR RFF DUTIES

10.2.1 Personnel recruited for RFF services should be resolute, possess initiative, competent to form an intelligent assessment of a fire situation and, above all, must be well trained and fully qualified. Ideally, every individual should be capable of sizing up changing circumstances at an aircraft accident and taking the necessary action without detailed supervision. Where the available staff displays limited capacity to use initiative, the deficiency must be made good by the provision of additional supervisory staff of a superior grade who will be responsible for exercising control of their crews. The officer responsible for the organization and training of the RFF service should be an experienced, qualified and competent leader. The capabilities of this officer should have been proved wherever practicable by training at a recognized RFF service training establishment and measures should be taken to ensure the officer's continuing proficiency.

10.2.2 Due regard should be given to the arduous nature of RFF duties and personnel selected for this work should be free from any physical disability which might limit their performance or which might be aggravated by a high level of exertion. Particular care should be taken in selecting personnel as wearers of respiratory protection equipment, where psychological factors are significant, in addition to physical suitability. (See also 6.2.)

## 10.3 MANAGEMENT OF RFF PERSONNEL

10.3.1 Full-time RFF personnel, where provided, may be assigned other duties, provided that the performance of these duties does not impair their ability to respond immediately to an emergency, or restrict their performance of essential training, inspections and equipment maintenance. These subsidiary duties could include fire prevention inspections, fire guard duties or other functions for which their equipment and training make them particularly suitable. Arrangements must exist for their immediate mobilization in the event of an emergency and, wherever possible, a crew assigned to subsidiary duties should travel in the RFF vehicle to which they are appointed, maintaining constant contact with the fire station by radio.

10.3.2 The airport emergency plan should provide for the alerting of all personnel who may contribute to the effective performance of post-accident operations in a support role to the RFF crews. (See 4.4.)

## 10.4 PHYSICAL AND MEDICAL FITNESS ASSESSMENTS FOR RFF SERVICES

10.4.1 As the nature of RFF operations involves periods of intense physical activity, all RFF personnel have to possess a minimum level of physical fitness and medical fitness to be able to perform the tasks associated with these operations. Physical fitness and medical fitness is often described as the overall physical condition of the body, which can range from peak condition for performance at one end of the spectrum to extreme illness or injury at the other. The key fitness components for RFF are generally aerobic fitness, anaerobic fitness, flexibility and medical fitness. Optimum physical fitness and medical fitness for RFF personnel would mean that a fire fighter is able to carry out RFF activities safely, successfully and without undue fatigue.

10.4.2 *Aerobic fitness* is the ability to continue to exercise for prolonged periods of time at low to moderate or high intensity. This is typically what limits the ability to continue to run, cycle or swim for more than a few minutes and is dependent upon the body's heart, lungs and blood to get the oxygen to the muscles ( $VO_2$ ) providing the sustained energy needed to maintain prolonged exercise. Typical aerobic

activities include walking, jogging, cycling, rope skipping, stair climbing, swimming, or any other endurance activities.

10.4.3 **Anaerobic fitness** works differently to aerobic fitness. It is an activity that requires high levels of energy and is done for only a few seconds or minutes at a high level of intensity. The term *anaerobic* means “without oxygen”. Participation in anaerobic activities leads to anaerobic fitness, which may be defined as higher levels of muscular strength, speed and power. Examples of anaerobic activities include heavy weight lifting, running up several flights of stairs, sprinting, power swimming, or any other rapid burst of hard exercises.

10.4.4 **Flexibility** refers to the ability to move the limbs and joints into specific positions at the end of their normal range of movement. Flexibility is important as it will allow the body to work in cramped positions without unduly stressing the muscles, tendons and ligaments and may reduce the risk of injury. Flexibility is best developed using slow controlled stretching exercises.

10.4.5 Physical fitness assessment should be catered to the components mentioned above. RFF services should develop various types of tests to ensure that these components are tested to determine if the RFF personnel has the required physical fitness level for the job. The physical fitness assessment should also be conducted at least once a year. The physical fitness assessments should be conducted for pre-employment entry as a fire fighter as well as ongoing physical fitness assessments for existing staff to ensure that RFF personnel are maintaining their level of physical fitness.

10.4.6 **Medical fitness** assessments specific to RFF Services should be developed. The medical fitness assessments should be conducted for pre-employment entry as a fire fighter as well as ongoing medical fitness assessments for existing staff. The frequency of medical fitness assessments should be determined by each agency. The medical fitness assessments should be used to identify any underlying medical conditions, which may pose a risk to the individual fire fighter, during physically demanding activities.

## 10.5 TASK RESOURCE ANALYSIS

10.5.1 **Introduction.** The following guidance describes the stages that should be considered by an airport operator in carrying out a Task and Resource Analysis (TRA) to establish justification as to the minimum number of qualified/competent personnel required to deliver an effective airport RFF Service RFFS to deal with an aircraft incident/accident. If an airport operator requires the RFFS to attend structural incidents and road traffic accidents in addition to aircraft incidents/accidents due regard must be given to the inability of not meeting required response times and robust procedures should be introduced accordingly.

10.5.2 **Purpose.** By using a qualitative risk based approach, which focuses upon probable and credible worst case scenarios a task and resource analysis seeks to identify the minimum number of personnel required to undertake identified tasks in real time before supporting external services are able to effectively assist RFFS.

10.5.2.1 Consideration should also be given to the types of aircraft using the aerodrome, vehicle(s) and the need for personnel to use self-contained breathing apparatus, handlines, ladders and other RFF equipment provided at the aerodrome associated with aircraft RFF operations. The importance of an agreed framework for incident command should form a primary part of the considerations. However, it must be achieved within the Safe Person Concept relative to each member state.

10.5.3 **General Information.** The airport operator should first establish the minimum requirements including: minimum number of RFFS vehicles and equipment required for the delivery of the extinguishing agents at the required discharge rate for the specified RFF category of the airport.

10.5.4 **Task Analysis/Risk Assessment.** A task analysis should primarily consist of a qualitative analysis of the RFFS response to a realistic, worst case, aircraft accident scenario. The purpose should be to review the current and future staffing levels of the RFFS deployed at the aerodrome. The qualitative analysis could be supported by a quantitative risk assessment to estimate the reduction in risk. This risk assessment could be related to the reduction in risk to passengers and aircrew from deploying additional personnel. One of the most important elements is to assess the impact of any critical tasks or pinch points identified by the qualitative analysis.

10.5.5 **Qualitative Approach.** The task analysis including a workload assessment aims to identify the effectiveness of the current staffing level and to identify the level of improvement resulting from additional staffing. A credible worst-case accident scenario should be analyzed to assess the relative effectiveness of at least two levels of RFFS staffing.

10.5.6 **Quantitative Risk Assessment.** This will generally be used to support the conclusions of the qualitative analysis by examining the risks to passengers and aircrew from aircraft accidents at the airport. This comparison of the risk allows the benefit of employing additional RFFS staff to be evaluated in terms of the risk reduction in passengers and aircrew lives saved. This could be expressed in monetary terms and may be compared with additional costs incurred in employing the additional personnel. However, this is of little, if any, value in determining minimum levels of personnel.

10.5.7 **Task Analysis.** The following items will assist in determining the basic contents of an analysis:

- a) Description of aerodrome(s) including the number of runways
- b) Promulgated RFFS Categories (Aeronautical Information Publication)
- c) Response Time Criteria (Area, times & number of Fire Stations)
- d) Current & future types of aircraft movements
- e) Operational Hours
- f) Current RFFS Structure & Establishment
- g) Current Level of Personnel
- h) Level of Supervision for each operational crew
- i) RFFS Qualifications/Competence (Training Programme & Facilities)
- j) Extraneous Duties (To include Domestic & First Aid Response)
- k) Communications & RFFS Alerting system including Extraneous Duties
- l) Appliances & Extinguishing Agents available
- m) Specialist Equipment- Fast Rescue Craft, Hovercraft, Water Carrier, Hose Layer, Extending Boom Technology
- n) First Aid- Role Responsibility
- o) Medical Facilities- Role Responsibility
- p) Pre-Determined Attendance: Local Authority Services- Police, Fire & Ambulance etc.
- q) Incident Task Analysis. (Feasible Worst Case Scenarios) (Workload Assessment) (Human Performance/Factors). To include: Mobilization, Deployment to Scene, Scene Management, Firefighting, Suppression & Extinguishment, Application of Complementary Agent(s), Post Fire Security/Control, Personnel Protective Equipment, Rescue Team(s), Aircraft Evacuation & Extinguishing Agent Replenishment. Note: The aim is to identify any Pinch Points within the current workload and proposed workload
- r) Appraisal of existing RFFS provision
- s) Future requirements. Aerodrome development & expansion

- t) Enclosures could include: Airport Maps, Event Trees to explain tasks & functions conducted by the RFFS etc.)
- u) Airport Emergency Plan and Procedures

Note.- The above list is not exhaustive and should only act as a guide.

#### 10.5.7.1 **Phase 1**

The airport operator must be clear as to the aims and objectives for the RFF services, and the required tasks that personnel are expected to carry out.

Example

Aim

To maintain a dedicated RFFS of qualified and competent fire and rescue personnel equipped with vehicles and specialist equipment to make an immediate response to an aircraft incident /accident on or in the immediate vicinity of the airport within the specified response time criteria.

Principal Objective of the RFFS

The principal objective of an RFFS is to save lives in the event of an aircraft accident or incident. For this reason, the provision of means of dealing with an aircraft accident or incident occurring at, or in the immediate vicinity of, an aerodrome assumes primary importance because it is within this area that there are the greatest opportunities of saving lives. This must assume at all times the possibility of, and need for, extinguishing a fire that may occur either immediately following an aircraft accident or incident, or at any time during rescue operations.

Tasks:

- a) Meet the required response time
- b) Extinguish an external fire
- c) Protect escape slides and exit routes
- d) Assist in the self-evacuation of the aircraft
- e) Create a survivable situation
- f) Rescue trapped personnel
- g) Maintain post fire security/control
- h) Preserve evidence

Note.- The above list is not exhaustive and all relevant tasks must be identified before moving to Phase 2. Each task/mission may include numerous functional activities/actions.

#### 10.5.7.2 **Phase 2**

Identify a selection of representative realistic, feasible accidents that may occur at the airport, this can be achieved by a statistical analysis of previous accidents on airports and by analysing data from both International National & Local sources.

Note - All incidents should involve fire to represent a feasible worst-case scenario that would require an RFFS response.

Examples:

- a) Aircraft engine failure on takeoff with a fire (aborted takeoff).
- b) Aircraft aborts and overruns into the Runway End Safety Area (RESA) with fire on takeoff.
- c) Aircraft into aircraft with fire (collision)
- d) Aircraft into structure- terminal building(s) with a fire.
- e) Aircraft leaves the runway on landing into the runway strip (full emergency evacuation).
- f) Internal aircraft fire (Cabin fire, baggage hold, cargo hold, avionics bay(s))

#### 10.5.7.3 **Phase 3**

Identify the types of aircraft commonly in use at the airport; this is important as the type of aircraft and its configuration has a direct bearing on the resources required in meeting Phase 1 above, it may be necessary to group the aircraft types in relation to common aircraft configurations for ease of analysis or identify precise aircraft type that may have a unique configuration.

Example

- a) Long wide-bodied aircraft with multiple passenger decks and multiple aisles.
- b) Long narrow-bodied aircraft with single aisle, high passenger density.
- c) Short narrow-bodied aircraft with single aisle, high passenger density.

A representative aircraft type can then be chosen:

- a) Airbus A 380
- b) Airbus A 340
- c) Airbus A 320
- d) Boeing 747
- e) Boeing 777
- f) Boeing 757
- g) Boeing 737

#### 10.5.7.4 **Phase 4**

Every airport is unique in that the location, environment, runway and taxiway configuration, aircraft movements, airport infrastructure and boundary etc. may present specific additional risks.

In order that the feasible accident scenario can be modeled/simulated a major factor is to consider the probable location for the most realistic accident type that may occur.

To confirm the location of the scenario it is important that a facilitator using a team of experienced fire service personnel, who have knowledge of the airport and the locations in which an aircraft accident is likely to occur evaluate the scenario.

The role of the facilitator is to seek agreement in identifying the credible worst-case locations and by using a scoring system place these locations in order of relevance & priority. The team must determine why the locations have been identified and provide a rationale for each location. One methodology would be to award a weighted number, to each location, the total numbers can then be added up in relation to each identified location.

### Example

The team may have identified that the following contributed to a worst-case location:

- a) Response Time
- b) Route to the accident site (on or off paved surfaces)
- c) Terrain
- d) Crossing procedures for active runway(s)
- e) Aircraft congestion on route (taxiways)
- f) Surface conditions
- g) Communications
- h) Supplementary water supplies
- i) Adverse weather conditions- Low visibility Procedures
- j) Daylight or darkness

An additional time delay for any of the factors listed above should be estimated and recorded & the location with the highest additional response time could be identified with the worst-case location.

It is important to note that the location of an accident could have an impact on the resources and tasks that will be required to be carried out by ARFF personnel.

From the above analysis a location or a number of locations could be identified, in agreement with the airport operator and the TRA facilitator.

### Example

1. Taxiway Bravo: Runway Holding Position Bravo 1- leading onto Runway 06L.
2. Runway 13- Runway & Service Road Crossing Point (Grid Reference A5).
3. Runway 28 Overrun RESA
4. Runway 24 Undershoot RESA
5. Aircraft Stand A33 (Alpha Apron).
6. Grid Reference A6 (Runway 06 Localiser Road)
7. Taxiway Alpha: Intermediate Taxi-Holding Position- A3
8. Aircraft Stand A5 (On taxilane).

#### 10.5.7.5 **Phase 5**

This Phase combines the accident types to be examined as described in Phase 2, with the aircraft identified in Phase 3 and the locations as described in Phase 4. The accident types should be correlated with the possible location, in some cases this could be in more than one location on an airport, for which a task and resource analysis needs to be carried out.

The above information is to be built into a complete accident scenario that can be analyzed by experienced supervisors & firefighters for the task and resource analysis in Phase 6.

### Example

#### Scenario No 1

Accident Type: Aircraft Overrun into Runway 06 RESA- Phase 2.

Aircraft Identified: Boeing 747-400- Phase 3.

Accident Location: Runway 06 RESA- Phase 4.

The Boeing 747 400 is a wide bodied multi deck aircraft, its typical seating configuration can be 340 Economy, 23 Business, and 18 First Class passengers on the lower deck. On the upper deck provision is made for a further 32 Business Class passengers, giving an estimated aircraft seating capacity of 413 excluding the crew. The aircraft typically has 4 exits on both sides of the lower deck and one each side of the upper deck.

During the take-off phase the aircraft suffers a fire in the number 3 engine and the pilot decides to abort the take-off. During this phase the fire develops rapidly and impinges on the fuselage. The aircraft overruns the runway and comes to rest in the RESA. Flight Deck Crew orders an evacuation.

The RFF services are informed by ATC and respond accordingly and the aerodrome emergency procedures are activated.

#### 10.5.7.6 Phase 6

By using a TRA facilitator with teams of experienced airport supervisors & firefighters the accident scenario(s) developed in Phase 5 are subject to a task and resource analysis carried out in a series of tabletop exercises/simulations.

When carrying out a task and resource analysis the principal objective should be to identify in real time and in sequential order the minimum number of RFF personnel required at any one time to achieve the following:

- a) Receive the message and dispatch the RFF service (the dispatcher may have to respond as part of the minimum riding strength)
- b) Respond utilizing communications, taking appropriate route and achieving the defined response criteria
- c) Position appliances/vehicles in optimum positions and operate RFF appliances effectively
- d) Use extinguishing agents and equipment accordingly
- e) Instigate Incident Command Structure- Supervisors
- f) Assist in passenger and crew self-evacuation
- g) Access aircraft to carry out specific tasks if required, e.g. firefighting, rescue
- h) Support and sustain the deployment of firefighting and rescue equipment
- i) Support and sustain the delivery of supplementary water supplies
- j) Need to replenish foam supplies

The task and resource analysis should identify the optimum time when additional resources will be available to support/augment and/or replace resources supplied by RFF services (Aerodrome Emergency Plan). It can also provide vital evidence to support the level of RFF vehicles and equipment.

In order to start a task and resource analysis the required category of the airport must be identified as required by the regulatory authority, this should confirm the minimum number of vehicles, and the minimum extinguishing agent requirements and discharge rates, this should also determine the minimum number of personnel required to functionally operate the vehicles & equipment.

The results of the analysis should be recorded in a table or spreadsheet format and should be laid out in a method that ensures that the following is recorded:



- a) Receipt of message and dispatch of the RFF response
- b) Time: This starts from the initial receipt of call and the time line continues in minutes & seconds until additional external resources arrive or the facilitator decides an end time
- c) List of assessed tasks functions and priorities are achieved
- d) The resources (personnel, vehicles and equipment) required for each task is defined
- e) Comments to enable team members to record their findings
- f) Identified Pinch points

#### 10.5.7.7 Working Example of a Qualitative Task Resource Analysis- Scenario 1.

Key to working example:

- Major Foam Tenders are identified as MFT A, B, C & D.
- Minimum numbers of personnel riding the MFTs are identified as: A1, A2, B1, B2 etc. See Table 1.

#### **Major Foam Tenders:**

- 4 MFTs carrying 11,00 Litres with a total water capacity of 44,000 Litres: (A, B, C & D)
- Minimum number of RFFS personnel: Total 14

#### **Supervisors:**

- Watch Commander: 1= A1
- Crew Commanders: 3= B1, C1 & D1

#### **Firefighters:**

- Total- 10.
- A2 & A3.
- B2 & B3.
- C2, C3, & C4.
- D2, D3, & D4.

Table 1: Minimum numbers of appliances/vehicles & personnel riding the MFTs

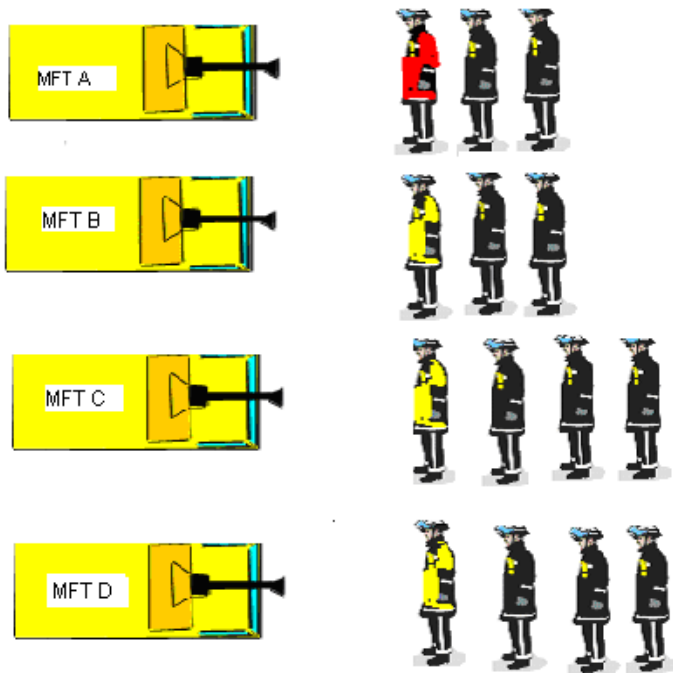

Notes:

1. For this example the RFFS is deployed from a single fire station at an airport with a single runway, designated 06-24.
2. The TRA should ensure that the tasks could be conducted within the Safe Person Concept relative to each member state.
3. Time has been defined in minutes and seconds.
4. For this TRA the dispatcher is outside of the minimum number of ARFF personnel.

Stated objectives for the RFFS:

- a) Instigate aerodrome emergency plan
- b) Respond within the required response time
- c) Select appropriate route & communications
- g) Position appliances in optimum positions and operate effectively
- h) Instigate Incident Command System
- d) Suppress/extinguish any fires
- e) Assist with self-evacuation of the aircraft
- f) If appropriate extinguish any internal fire
- g) If required ventilate aircraft to create survivable conditions
- h) Maintain post fire control of the critical area
- i) Preserve evidence

**Table 2**

Task and Resource Analysis

TIME	TASKS	RESOURCES	COMMENTS
00.00	Call received from ATC as aircraft accident runway 06 RESA. Boeing 747-400.	Dispatcher	Achieved
00.00	ARFF personnel mobilized by dispatcher.	Dispatcher	Achieved
00.15	Call made to operate the airport emergency plan.	ATC/Dispatcher/Operations Unit.	Achieved- ATC
00.30	Personnel donning in appropriate PPE.	Minimum riding strength	Achieved
00.40	Route selected & all appliances mobile en route to 06 RESA.	MFTs A, B, C, & D.	Achieved- Supervisors & Drivers.
00.50	Supervisor(s) utilize appropriate communications (RTF): Discreet frequency, ATC, Local Authority etc.	Supervisor(s)	Achieved Note: Aircraft may have already instigated evacuation (Air Crew)
02.00	All appliances in position: Priority identified by Supervisor(s) to extinguish ground pool fire and fire in number 3 engine that is impinging on fuselage.  A1 instigates ICS	Supervisors & Drivers.  MFTs A, B, C & D.  A1 Supervisor. B1 Supervisor. C1 Supervisor D1 Supervisor	Achieved  A, B & C deploy monitors.
02.15	Create and maintain survivable conditions for the passengers to reach a place of safety. Complementary agent required. D1 is Supervisor. D2 is Pump Operator Breathing Apparatus Entry Control Officer (BAECO).	A2 A3 B1 B2 B3 C1 C2 C3 D1 D2 D3 D4 D3 deploy, use complementary agent donned in RPE.	
03.15	All external fires extinguished.	MFTs A, B, C, & D. All Crewmembers.	Achieved.
03.20	Assist with self-evacuation, and maintain survivable conditions for the passengers to reach a place of safety.	MFTs A B. B1 A2 A3 B2 B3	Achieved: Hand lines deployed accordingly
03.20	Crew prepares to enter aircraft in RPE.	MFT D D1 D3 & D2 (Pump)	Achieved D1 D3 Briefed by BAECO.
03.20	Crew prepares appropriate entry point and hand line.	C1 C2 C3 C4	Achieved by use of: Specialist Vehicle/Equipment/ Ladder.

	Note: MFT A maintains post fire control.	A2 A3	Achieved
03.55	Crew enters aircraft in RPE with hand line. (BAECO).  Ladder made safe for internal crew.  Crews assist with hand line for BA entry team	D1 D3. D4  C4  B2 B3	Achieved  Achieved.  Achieved.  Achieved
04.15	Following self-evacuation of aircraft provide assistance with mustering passengers and crew to place of safety.	C1 C2 C3.	Achieved. Assistance provided by aircraft crew and additional responders from airport in accordance with the emergency procedures.
04.15	A2 remains as Monitor/Turret operator, and provides escape route protection.	MFT A	Achieved
04.30	Supervisor A1 liaises with ATC, Rendezvous Point Officer & arriving emergency services to ensure appropriate resources are brought forward to the accident site/location.	A1	Achieved
04.50	Supervisor A1 instructs Airside Operations to assist in containing exiting passengers and crew and obtaining a head count of survivors.	A1	Achieved
04.55	D1 reports 20 survivors still on board aircraft require medical aid and assistance. There is no smoke in cabin or flight deck areas and survivors are having no difficulty with breathing.	D1 A1	Achieved
05.05	External emergency services are brought forward to the accident site with additional equipment to support the removal of the remaining survivors and to transport the survivors to the appropriate safety zone.	A1 & external commanders: <ul style="list-style-type: none"> <li>• Police</li> <li>• Fire</li> <li>• Ambulance</li> <li>• Medical</li> <li>• Etc</li> </ul>	Achieved

	Additional Points		
	Note 1: At this point the airport emergency plan is fully instigated and the supporting services can relieve D1 D3, provide supplementary water if required from the nearest hydrant or emergency water supply, assist in the deployment of specialist fire ground equipment and if required support the teams that are engaged in removing the survivors to a place of safety.		
	Note 2: The facilitator may decide to terminate the analysis at this point or continue with the exercise to evaluate specific elements of the emergency plan. e.g. Preservation of Evidence.		

## Notes:

- a) It can be seen that ten firefighters and four supervisors including the officer in charge are required to achieve the above supported by four Major Foam Tenders.
- b) The time line can be further verified by the use of practical exercises & individual analysis to establish if the times are realistic and achievable for each task and function.
- c) Each of the above tasks can be sub-divided into individual functions associated with the specific task performed at a particular time.

## Example:

- a) How long does it take to don protective clothing?
- b) How long does it take to don self-contained breathing apparatus?
- c) How long does it take to slip and pitch a ladder
- d) How long does it take to open an aircraft door from the head of a ladder? (If required).
- e) How long does it take to deploy one, two three (etc.) lengths of delivery hose?
- f) How long does it take to carry any item of rescue equipment over a specified distance and get to work?

**Table 3 RFFS Activities**

Time Line Assessment for Personnel: Firefighters and Supervisors

This Table gives an indication of the time line from the above analysis and can be utilized to verify an individual task, function or identify “Pinch Points” ensuring each task is achievable effectively within the time line.

<b>Task Time</b>	<b>A1</b>	<b>A2</b>	<b>A3</b>	<b>B1</b>	<b>B2</b>	<b>B3</b>	<b>C1</b>	<b>C2</b>	<b>C3</b>	<b>C4</b>	<b>D1</b>	<b>D2</b>	<b>D3</b>	<b>D4</b>
00.00														
00.15														
00.30														
00.40	<b>A1</b>	<b>A2</b>	<b>A3</b>	<b>B1</b>	<b>B2</b>	<b>B3</b>	<b>C1</b>	<b>C2</b>	<b>C3</b>	<b>C4</b>	<b>D1</b>	<b>D2</b>	<b>D3</b>	<b>D4</b>
00.50														
02.00	<b>A1</b>			<b>B1</b>			<b>C1</b>				<b>D1</b>			
02.15		<b>A2</b>	<b>A3</b>	<b>B1</b>	<b>B2</b>	<b>B3</b>	<b>C1</b>	<b>C2</b>	<b>C3</b>		<b>D1</b>	<b>D2</b>	<b>D3</b>	<b>D4</b>
03.15														
03.20		<b>A2</b>	<b>A3</b>	<b>B1</b>	<b>B2</b>	<b>B3</b>	<b>C1</b>	<b>C2</b>	<b>C3</b>	<b>C4</b>	<b>D1</b>	<b>D2</b>	<b>D3</b>	
03.20														
03.20		<b>A2</b>	<b>A3</b>											
03.55					<b>B2</b>	<b>B3</b>				<b>C4</b>	<b>D1</b>		<b>D3</b>	
04.15							<b>C1</b>	<b>C2</b>	<b>C3</b>					
04.15														
04.30	<b>A1</b>													
04.50	<b>A1</b>													
04.55	<b>A1</b>										<b>D1</b>			
05.05	<b>A1</b>													

Notes:

From the above Table it can be seen that a potential Pinch Point exists with Firefighters A2 & A3. However, the tasks that they are performing are achievable as A2 & A3 are already utilizing a foam hand line to maintain the evacuation route and maintaining Post Fire Control. This is considered logical and an achievable process for this crew.

10.5.7.8 *Conclusion.* A task analysis can be as detailed as necessary. The aim is to itemise the knowledge and practical skills (doing) involved in carrying out the task or function effectively and to the correct standard of competence based on a qualitative analysis. Having gathered the appropriate data and agreed the outcome, the TRA should enable an RFFS to confirm and subsequently provide the correct level of vehicles, equipment and personnel. It would also enable the RFFS to develop a training specification and a learning programme can then be designed around role and task. When planning a Task & Resource Analysis ask the following questions:

- a) What is done?
- b) Why is it done?
- c) When is it done?

- d) Where is it done?
- e) How is it done?
- f) Who does it?

10.5.7.9 It is often difficult to assess the overall effectiveness of a complete unit by observation only. However, observation/demonstration does allow you to assess the effectiveness of individual units and any element(s) of the emergency arrangements. Documentary evidence relating to previous accidents or exercises may also assist in establishing if the current RFFS is staffed at an appropriate level. The overall objective is to be satisfied that the RFFS is organized, equipped, staffed, trained and operated to ensure the most rapid deployment of facilities to maximum effect in the event of an accident. The above process can also be used to identify equipment shortages and training needs for personnel required to deal with identified tasks.

## Chapter 11

### EMERGENCY ORGANIZATION

#### 11.1 AIRPORT EMERGENCY PLAN

11.1.1 Every airport should establish an emergency plan to deal with aircraft emergency situations. The following instructions are primarily for the aircraft fire accidents and incidents. The other incidents, such as medical emergencies including pandemic and sabotage including bomb treat can be found in the Aerodrome Service Manual Part 7 A erodrome Emergency planning. The plan should include a set of instructions dealing with the arrangements designed to meet emergency conditions and steps should be taken to see that the provisions of the instructions are periodically tested. Only in this way can it be established that the organization is capable of coping with every likely contingency and that the authorities, as well as each individual, services and agencies concerned, will be acquainted and familiar with the action to be taken. These instructions should set out in sequence the specific duties of each section concerned (e.g. air traffic control, RFF service, security managers, aerodrome operations managers). They should cover the arrangements for calling the rescue and firefighting service to aircraft accidents, both on and off the airport and for the summoning of assisting municipal services, rescue and medical, where available. The chief link in the organization is that between RFF service and air traffic control, and it is essential that the closest possible liaison between these two services be maintained at all times. In the event of an emergency situation, an emergency vehicle responding to the emergency must be given priority over all other surface movement traffic. Once an accident has occurred the direction and control of the RFF operation must be left to the airport fire service officer-in-charge. The procedure of the emergency organization should provide for the rendezvous point(s) and staging area(s) to be used by the assisting services involved. A *rendezvous point* is a pre-arranged reference point, i.e. road junction, cross-road or other specified place, to which personnel/vehicles responding to an emergency situation initially proceed to receive directions to staging areas and/or the accident/incident site. It is recommended that a process be established to assist responding external agencies with directions to the designated rendezvous point. A *staging area* is a pre- arranged, strategically placed area, where support response personnel, vehicles and other equipment can be held in readiness for use during an emergency. Normally, one of the staging areas is located in the vicinity of the fire station. The subject of airport emergency planning is given detailed consideration in the *Airport Services Manual* (Doc 9137), Part 7. - *Airport Emergency Planning*.

11.1.2 A system for locating and reaching each accident site in minimum time, with adequate rescue,

firefighting and medical equipment, should be employed at each airport. A detailed grid map(s) (see Figure 11-1) will be helpful in this regard. The grid maps should reflect a distance of at least 1000 m beyond the threshold and the airport perimeter. Studies of the ICAO Accident Incident Data Reporting (ADREP) System show that a large (more than 25%) portion of accidents occurred on the area (1000 m long and 60 m width) beyond the runway end.

11.1.3 It is recommended that two grid maps be provided: one map depicting confines of airport access roads, location of water supplies, rendezvous points, staging areas, railways, highways, difficult terrain, etc. (see Figure 11-1), and the other of surrounding communities depicting appropriate medical facilities, access roads, rendezvous points, etc. within a distance of approximately 8 km from the centre of the airport (see Figure 11-2). Where more than one grid map is used, the grids should not conflict, and must be immediately identifiable to all participating agencies.

11.1.4 Copies of the map(s) should be maintained at the emergency operations centre, at the airport operations office, at the air traffic control tower, at airport and local fire stations in the vicinity, at all local hospitals, at police stations, at local telephone exchanges, and at other similar emergency and information centres in the area. In addition, copies of the maps should be kept on all RFF vehicles and such other supporting vehicles required to respond to an aircraft emergency. Maps of this type are ruled off in numbered grids and marked for easy identification of any point within the map area. Instruction classes on the use of such maps should be held periodically. When two or more airports are closely located the preparation of the grid maps may need to be co-ordinated to avoid any confusion.

11.1.5 The responsible parties should be kept informed as to any impairment of the emergency access roads (see 3.2), such as their being closed for repairs or unusable because of high water, snow, etc. If the airport is fenced, keys to gate locks should be carried on each piece of emergency apparatus, by airport police/security and other appropriate local authorities. Perimeter fences should have provision for rapid egress to these areas by way of frangible barriers (crash gates) or similar.

11.1.6 *Standby positions.* One or more standby positions on the movement area should be considered. The purpose of standby positions is to pre-position the RFF vehicles on selected locations of the movement area so as to minimize the response time in case of full emergency, local standby (see 11.2. I) or when the response time is seriously affected by the location of the fire station or other physical characteristics of the airport. Location of the RFF vehicles on the standby positions should not:

- a) interfere with or disrupt the operation of the electronic navigational equipment;
- b) penetrate the obstacle clearance surfaces or interfere with normal aircraft taxiway routes; and
- c) increase response time to any part of the movement area.

A source of electric power at standby positions may be necessary to provide heating or cooling capability and to maintain radio communication.

11.1.7 Adverse weather or poor visibility conditions may restrict the normal movement of RFF vehicles on the airport or its vicinity. When such conditions are likely to be found additional procedures should be established so as to:

- a) enable fire station personnel to remain informed on current visibility conditions at the airport, for instance by monitoring the control tower frequency or automatic terminal information service (ATIS) frequency, or any other form of communication:



b) determine the response times of all mutual aid agencies which are an integral part of the airport emergency planning process during adverse weather conditions and, where possible, seek to improve them;

c) encompass in the training programme a thorough knowledge of the airport and its immediate vicinity; and

d) place the RFF personnel on standby alert status when the airport visibility has deteriorated below a predetermined level established by the airport authority. The standby alert status should be continued until visibility conditions improve or aircraft operations are terminated.

11.1.8 As indicated in 11.1.1, a mutual aid programme should be worked out with neighborhood fire and rescue units and other appropriate local units. Some of the arrangements to be made are described below.

11.1.9 Local fire agencies be included in aircraft RFF training activities conducted at the airport by participating in drills, tests, and aircraft familiarization programmes. Such activities should be specifically pointed towards increasing the utility of local fire defence personnel in handling off-airport accidents and assisting in a mutual aid capacity at on-airport accidents. Confidence in handling aircraft fires can only be attained by following the requirements in accord with the principles of Chapter 14.1 Training. Some training examples are frequent training sessions of realistically simulated accidents including aircraft incident support training.

11.1.10 When local fire agency crews arrive at the scene of an aircraft fire first, they should know how to proceed with the fire suppression work. In such situations, upon arrival of the specialized airport equipment and personnel, the officer in charge of the airport emergency crew should consult with the other officer-in-charge on what efforts have not been successfully completed and then identify what assistance is required to bring the incident to a successful conclusion. The RFF crew should concentrate on the (fire) safety at the crash scene. After evacuation is completed, all agencies should concentrate on final extinguishment required. The division of responsibilities in any given situation is a matter for individual determination by those in charge in accordance with previous mutual aid arrangements and with legal assignments. Where accidents occur beyond the airport perimeter it is important that external responding agencies, such as fire services, have as a minimum a base understanding in dealing with aviation incidents.

11.1.11 Local fire agencies should be tied in closely with airport emergency alarm services, preferably by direct line telephone. Having been provided with grid maps, they should be able to respond quickly to the designated staging area, rendezvous point or accident site in minimum time. They should be encouraged to carry equipment appropriate for aircraft RFF operations.

11.1.12 Ambulance and medical services, like RFF services, are necessary to administer aid to the injured. Response of such aid to an aircraft accident site should be automatic. Some ambulance and medical services may be an integral part of the airport RFF organization and this is recommended where feasible. Such services should be available during all operating periods on an identical schedule with the companion activity. Prearrangements in the emergency plan with local, private or public ambulance and medical services also should be arranged to assure support. Where a permanent airport-based ambulance service is not feasible and to supplement any such services, prearrangements with local, private or public ambulance and medical services should be arranged to assure prompt dispatch of a satisfactory assignment of personnel, equipment, and medical supplies. It is of special importance that aircraft RFF personnel be trained in, as a minimum, basic first-aid practices in accord with Chapter 14.1, Training.

1 1.1.13 Airport fire equipment required to maintain RFF category should not be used for fires off the airport while flight operations are still in progress.

## 11.2 AIRCRAFT EMERGENCIES FOR WHICH SERVICES MAY BE REQUIRED

11.2.1 Aircraft emergencies for which services may be required can be classified as:

- a) *aircraft accident* - an aircraft accident which has occurred on or in the vicinity of the airport;
- b) *full emergency* - to be instituted when it is known that an aircraft approaching the airport is, or is suspected to be, in such trouble that there is danger of an accident; and
- c) *local standby* - to be instituted when an aircraft approaching the airport is known or is suspected to have developed some defect but the trouble is not such as would normally involve any serious difficulty in effecting a safe landing. This includes bomb threats and other incidents.

11.2.2 For each of these aircraft emergencies, air traffic control is expected to take action as described below. giving where necessary rendezvous point and airport entrance to be used.

### 11.2.3 *Aircraft accident*

Notify the RFF service, providing information on the location of the accident and all other essential details. These details should as a minimum include:

- type of aircraft;
- type of accident/incident; and
- time and (grid)location of the accident/incident.

Subsequent calls may expand this information by providing details on the number of occupants, fuel on board, aircraft operator, if appropriate, and any dangerous goods on board, including quantity and location, if known.

b) Initiate the calling of the police and security services and the airport authority in accordance with the procedure in the airport emergency plan, giving grid map reference, rendezvous point and/or staging area and, where necessary, airport entrance to be used.

### 11.2.4 *Full emergency*

a) Notify the RFF service, if applicable to stand by at the predetermined standby positions.. These details should ideally include:

- type of accident/incident
- type of aircraft;
- fuel on board;
- number of occupants, including special occupants  
handicapped, immobilized, blind, deaf;
- nature of trouble;
- runway to be used;
- estimated time of landing;
- any dangerous goods on board, including quantity

and location, if known.

b) Initiate the calling of the mutual aid fire agency/agencies and other appropriate organizations in accordance with the procedure laid down in the airport emergency plan, giving where necessary rendezvous point and airport entrance to be used.

11.2.5 *Local standby.* Call the RFF service to stand by, if applicable at the predetermined standby positions. Provide all essential details. These details should include:

- type of accident/incident;
- type of aircraft;
- fuel on board;
- number of occupants, including special occupants - handicapped, immobilized, blind, deaf;
- runway to be used;
- estimated time of landing;
- aircraft operator, if appropriate; and
- any dangerous goods on board, including quantity; and location, if known.

11.2.6 The responsibility on the scene for dealing with the emergency rests with the RFF service officer-in-charge who is normally responsible for assuring that there is no further need for the RFF service before returning to the station. Should another emergency occur before the previous one is finally dealt with, the air traffic control officer may be responsible for notifying the RFF service so that redeployment of resources can be made, and for all other action as set out for each type of emergency.

11.2.7 Air traffic control, where available, should have facilities to maintain continuous communication with as well as to inform the officer-in-charge of the RFF service of last minute changes in the distressed aircraft's flight plan or emergency conditions existing. When advised of the situation, aid to the extent needed or judged desirable should be put into effect by the officer-in-charge of the RFF service. Air traffic control should then notify the pilot of the aircraft in distress of the precautionary action being taken at the airport.

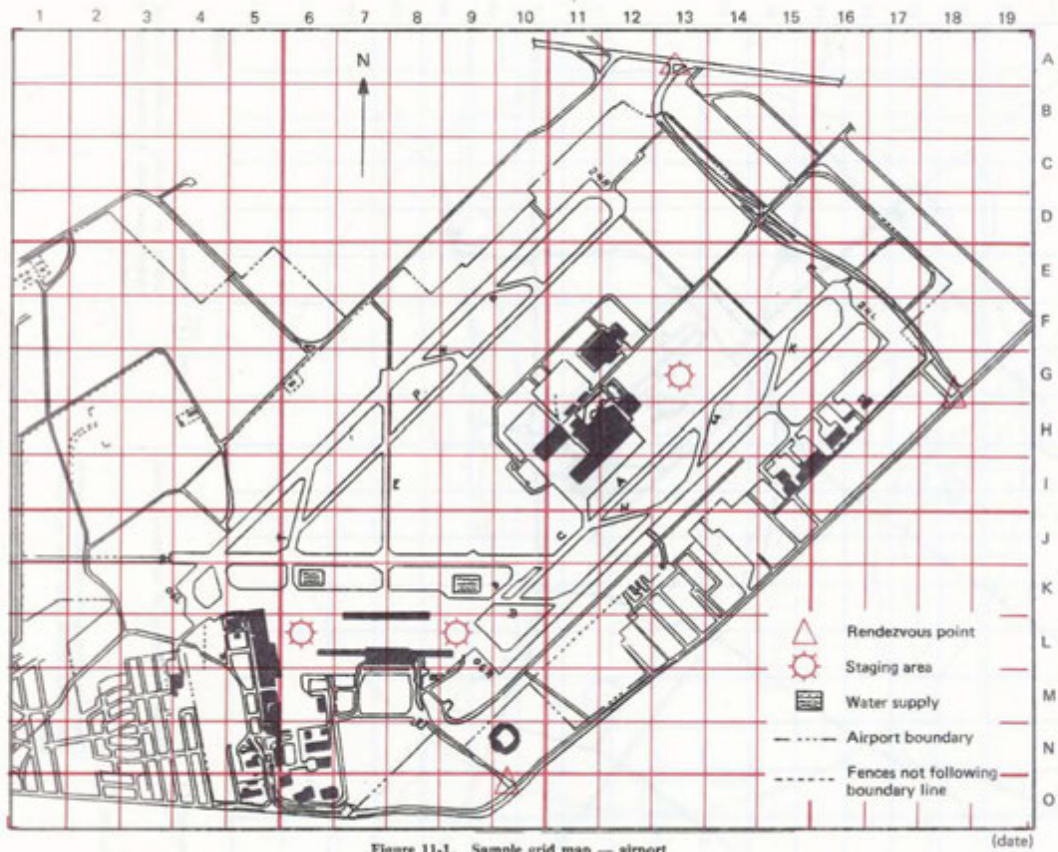

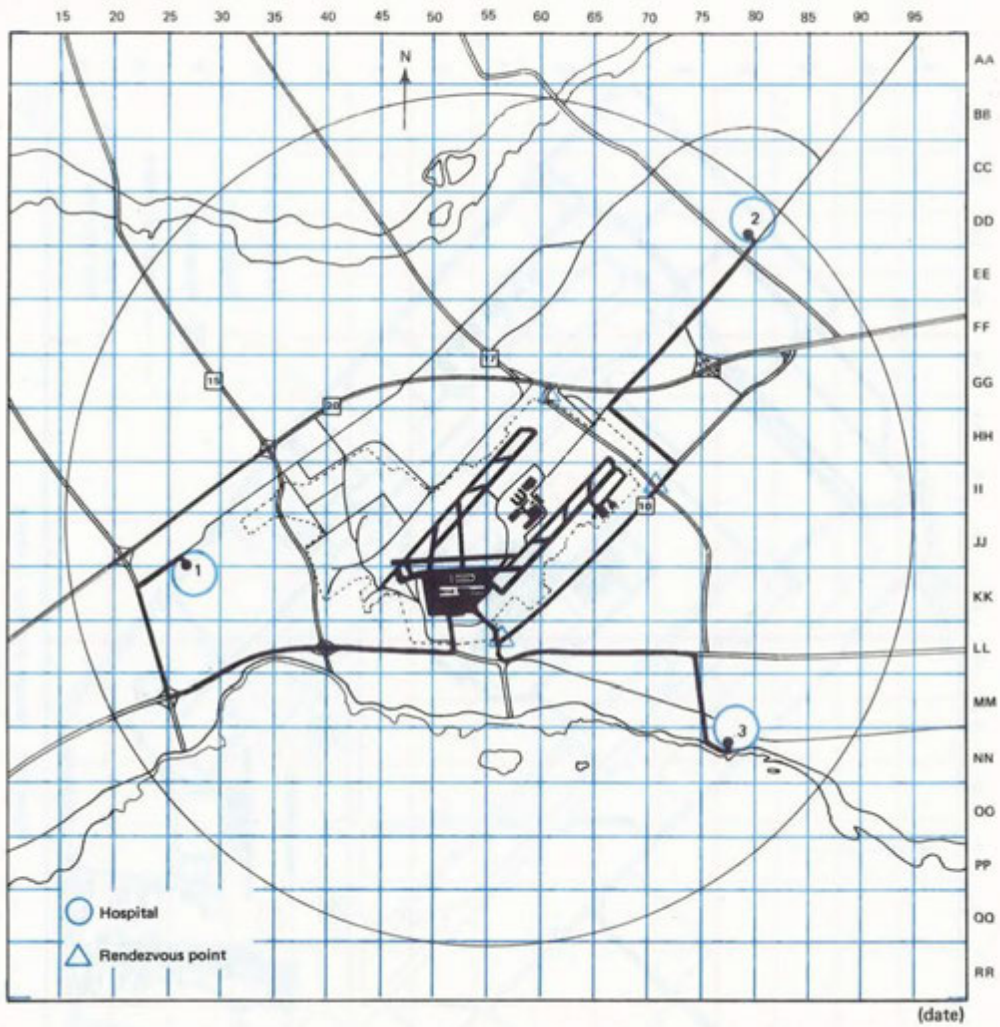

- Hospital ① 55 beds  
Capable of handling all emergency medical cases
- Hospital ② 70 beds  
Capable of handling most emergency medical cases except special cases such as extensive burns

- Hospital ③ 40 beds  
Capable of handling common emergency medical cases such as simple wounds or fractures

Figure 11-2. Sample grid map — airport and surrounding community

## Chapter 12

### AIRCRAFT FIREFIGHTING AND RESCUE PROCEDURES

#### 12.1 FEATURES COMMON TO ALL EMERGENCIES

12.1.1 Upon notification from air traffic control announcing an aircraft emergency, the required equipment is dispatched to the scene of the accident or to the predetermined standby positions. Once the call has been received, all subsequent RFF action will be the responsibility of the airport RFF service officer-in-charge.

12.1.2 Runway standby positions for RFF vehicles in anticipation of an emergency may be predetermined, and documented to provide the best possible coverage.

12.1.3 For emergencies involving gear malfunction or tire difficulty, there is always a possibility of the aircraft veering off the runway and possibly hitting emergency equipment. In such cases, it is preferable for the emergency equipment to be located near the point of touchdown and then to follow the aircraft down the runway after ground contact.

12.1.4 Response by RFF equipment to off-airport accident(s) should be done in accordance with off aerodrome response procedures and existing mutual aid agreement(s). Communication should be maintained between RFF vehicles, the fire station and air traffic control. Wherever possible, mutual aid resources should monitor predetermined frequencies.

12.1.5 Additional resources should be dispatched when the accident site is known to be beyond normal fire-protected zones (underground water mains and hydrants) or where water relays may be required. Prearrangements should be made to assure that additional supplies of extinguishing agents are brought to the accident scene.

12.1.6 Pre-incident planning of off-airport conditions should be made to prevent delays at time of emergency. Significant factors should be charted on the grid maps carried in RFF vehicles.

12.1.7 All personnel operating directly in the involved area of the crash should be provided with adequate protective clothing. Details on protective clothing can be found in Chapter 6. The training of rescue personnel should stress the value and the limitations of their protective equipment to avoid a false sense of security and to recognize that they could unwittingly lead the occupants of the aircraft through a dangerous atmosphere.

12.1.8 Lines to be used in fire attack should be charged after equipment is properly positioned. If no fire is visible, all equipment should be staged for immediate response if necessary.

12.1.9 Should spill of a flammable liquid occur without fire breaking out, it is important to eliminate as many ignition sources as possible while the spill is being neutralized or covered with foam. Engine ignition sources should be made inert or cooled. There may be enough residual heat in turbine aircraft engines to ignite fuel vapors up to 30 minutes after shutdown or 10 minutes on piston engines.

12.1.10 A continuous water supply is essential and is usually not available at all points, provisions should be in place to ensure that the required fire flow be maintained. It is important that prearrangements also include additional emergency resources.

12.1.11 Rescue operations should be accomplished through regular doors and hatches wherever possible but RFF personnel must be trained in forcible entry procedures and be provided with the necessary tools.

Note. - In a number of cases, misuse of forcible entry tools has resulted in unnecessary fuel spills increasing the fire hazard.

12.1.12 Rescue of aircraft occupants is a priority and should proceed with the greatest possible speed. Evacuation of injured occupants from a dangerous environment in the fire threatened area should be done with care so as not to aggravate their injuries.

12.1.13 Broken fuel, hydraulic fluid (flammable type), alcohol and oil lines should be plugged or crimped when possible to reduce the amount of spill and extent of fire.

12.1.14 If the source of heat and fire cannot be controlled, fuel tanks exposed but not involved should be protected by appropriate agents to prevent involvement or explosion.

12.1.15 Aircraft windows maybe used for rescue or for ventilation. Some are designed to be used as emergency exits. On all aircraft these exits are identified and have latch release facilities on both the outside and inside of the cabin.

12.1.15.1 Cabin doors may be used as emergency exits except when they are not operationally available. With some exceptions these doors open outwards. When exits are used for ventilation they should be opened on the down-wind side.

12.1.16 The “No Smoking” rule must be rigidly enforced at the scene of the accident and in the immediate vicinity.

## 12.2 FIGHTING AIRCRAFT FIRES

12.2.1 The prime mission of the airport RFF service is to control the fire in the critical area to be protected in any post-accident fire situation with a view to permitting the evacuation of the aircraft occupants. Equipment and techniques recommended are generally directed toward this goal. The recommendations in this section are for guidance of the officer-in-charge when responding to aircraft accident/incident.

12.2.2 *Class A fires.* Fires involving upholstery and similar solid combustibles are Class A materials, which require cooling and quenching for extinguishing. The officer-in-charge may find it advantageous to use water, preferably a water fog, on fires of this type. Experience, planning and a knowledge of how to use available equipment and agents to best advantage are the best guide in making a decision.

12.2.3 *Hot brakes and wheel fires.* The heating of aircraft wheels and tires presents a potential explosion hazard, greatly increased when fire is present. In order not to endanger the members of the airport RFF service needlessly, it is important to distinguish between hot brakes and brake fires. Hot brakes will normally cool by themselves without the use of an extinguishing agent. Most aircraft operating manuals for propeller driven aircraft recommend that flight crew members keep the propeller forward of the wheel turning fast enough to provide an ample cooling airflow. Most wheels of jet aircraft have fusible plugs, which may melt and deflate the tire before dangerous pressures are reached. When responding to a wheel fire, RFF members should approach the wheels with extreme caution in a fore or aft direction angle and never from the side in line with the axle. Since the heat is transferred to the wheel from the brake it is

essential that the extinguishing agent be applied to this area.

12.2.4 Too rapid cooling of a hot wheel, especially if localized, may cause explosive failure of the wheel. Solid streams of water may be used as a last resort. Water fog or indirect solid stream can be used to cool hot brakes. Dry chemical is an effective extinguishing agent but is not recommended as an effective agent on this type of fire.

12.2.5 *Rocket engine fires.* Some civil and military aircraft are equipped with auxiliary rocket engines to provide standby thrust from emergency or for jet assisted take-off (JATO) use. These are usually mounted in the nacelles, in the fuselage tail cone, in the belly of the fuselage, or on the sides or bottom of the fuselage.

12.2.6 If a fire surrounds the rocket engines, caution should be used in approaching the area. No attempt should be made to extinguish the engines if they should ignite. Water or foam may be used effectively to control the fire around the rocket motors, but they cannot be extinguished because of the self-contained oxidizer in the propellant. They burn very intensely for a short duration; however, they will normally not contribute significantly to the damage, since their chambers are so well insulated that it takes several minutes of very intense heat to ignite them. This heat will normally have done irreparable damage or caused fatalities before ignition of the rocket engines occurs.

12.2.7 If fire does not occur, igniters and ignition cables should be removed from unexpended rocket engines on the crashed aeroplanes by appropriately trained personnel as soon as possible to reduce the possibility of inadvertent ignition from stray voltage entering the ignition wiring.

12.2.8 *Confined engine fires (piston).* When engine fires are confined within the nacelle, but cannot be controlled by the aircraft extinguishing system, clean agents should be applied first as these agents are more effective than water or foam inside the nacelle. Dry chemical may be used but may cause further damage to the aeroplane. Foam or water spray should be used externally to keep adjacent aircraft structures cool. The propellers should be approached with caution and never be touched, even when at rest.

12.2.9 *Confined turbine engine fires (jet).* Fires confined to the combustion chambers of turbine engines are best controlled when the flight crew is in a position to keep the engine turning over and it is safe to do so from the viewpoint of aircraft evacuation and other safety considerations. Fire fighters will have to stand clear of the exhaust but may have to protect combustibles from exhaust flames. Fires outside the combustion chambers of turbine engines but confined within the nacelle are best controlled with the aircraft built-in extinguishing system. If the fire persists after the built-in system has been expended and the turbine shut down, clean agent may be used to attempt extinguishment. Dry chemical may be used but may cause further damage to the aeroplane.

12.2.10 Foam or water spray should be used externally to keep adjacent aircraft structures cool. Foam should not be used in the intake or exhaust of turbine engines unless control cannot be secured with the other agents and the fire appears to be in danger of spreading.

12.2.11 RFF personnel should stay at least 10 m from the front and side intake of an turbine engine to avoid being ingested.

12.2.12 Remain up to 500 m from the rear depending on the size of the aeroplane to avoid the jet blast danger area.

12.2.13 *Titanium fire control.* Some engines have titanium parts which, if ignited, cannot be



extinguished with the conventional extinguishing agents available to most RFF crews. If these fires are contained within the nacelle, it should be possible to allow them to burn out without seriously threatening the aircraft itself as long as:

- a) there are no external flammable vapour -air mixtures which could be ignited by the flames or hot engine surfaces; and
- b) foam or water spray is available to maintain the integrity of the nacelle and surrounding exposed aircraft structures.

12.2.14 *Fire situations involving rear mounted aeroplane engines.* Engines mounted on the rear fuselage areas of aircraft or in association with the vertical stabilizer present special firefighting problems. In some cases, where the engines are mounted on the sides of the fuselage, they may have fire access panels which are so situated as to preclude the complete entry of the nozzles on extending applicators on fire extinguishing apparatus.

12.2.15 Another problem arises due to the height of these engines above ground level. Heights of up to 10.5 m may be encountered and these will require the provision of ladders, elevated working platforms on fire appliances and extensible applicators for delivering suitable extinguishing agents. One further aspect to be considered is that personnel and vehicles operating at an engine fire, should not position themselves immediately below the engine where they may be at risk from running fuel, melted metal or ground fire situations. Operating positions outboard, in front, or to the rear, of engines will permit extinguishing agents to be delivered provided that there is a suitable applicator or the range and pattern of the discharge can deliver the chosen agent effectively.

12.2.16 The choice of the extinguishing agent to be used will be a matter for local decision but, as with all firefighting, the operational objective must be for rapid fire control and for the minimum amount of consequential damage as a result of firefighting activities. Some agents, notably clean agents dry chemical powder and, to a lesser extent, CO<sub>2</sub>, can achieve fire control in the screened areas within an engine without any contamination of the various components and ancillary systems. They are effective on fires involving fuels and electrical equipment as well as on running fuel situations which may produce fires at ground level. Where an engine fire situation has developed, priority will be given to exposures. It is important to inform aircraft operators of the nature of the agent used when the incident is concluded so that they may take preventive action against corrosion or other effects as the situation may require.

12.2.17 *Magnesium fire control.* The presence of magnesium alloys in aircraft structures introduces an additional problem to fire extinguishment in situations where this metal becomes involved in an aircraft fire. The form and mass of magnesium-based components in normal airframes is such that ignition does not occur until there has been considerable exposure to flame but exceptions occur in the thin forms of magnesium found in some aircraft power plant and landing gear components.

12.2.18 Magnesium fires may be attacked in their incipient stages by extinguishing agents specifically designed for combustible metal fires, but where a large mass of magnesium becomes involved the application of large volumes of coarse water streams provides the best ultimate control method. Attack by water streams is undesirable where the primary fire control technique is with foam as the water streams would damage the foam blanket. Following completion of rescue and all possible salvage of effects it is advisable to apply coarse water streams to still-burning magnesium components even if the immediate result might be a localized intensification of flame and considerable sparking.

## 12.3 RESCUE TACTICS AND ASSOCIATED EQUIPMENT REQUIREMENTS

12.3.1 Rescue *tactics*. Before attempting to specify the tactics and equipment to be used in rescue operations following an aircraft accident it will be necessary to identify the tasks to be performed. First, the term *rescue* must be taken to include protection of the routes followed by occupants of the aircraft who are able to escape from the aircraft. The activities external to the aircraft may include firefighting, the blanketing of fuel wetted areas adjacent to the aircraft, the assistance in the effective use of the emergency escape equipment deployed from the aircraft and the provision of lighting where this would expedite the evacuation of the aircraft and the assembly of its occupants in a safe area. It will be obvious that entry to the aircraft at this time should not be attempted by any of the routes which are in use by escaping occupants. It will also be obvious that evacuation from the aircraft and any operations within the fuselage cannot be conducted effectively if a fire situation exists which imperils the occupants or the rescue forces. While the rescue of all occupants may be considered as the primary objective, the over-all requirement is to create conditions in which survival is possible and in which rescue operations may be conducted. For this reason it may be essential to commence firefighting operations before attempting to rescue any one of the occupants, as failure to suppress the fire or render a fuel wetted area fire safe may preclude the survival of everyone aboard.

12.3.2 Second, the saving of those occupants unable to make their escape without direct aid may be a long and arduous task, involving the use of specialized equipment and personnel other than those primarily provided for RFF purposes. The support for the primary rescue element may come from medical teams, from the aircraft operator's sources and from externally based emergency services who respond to aircraft emergencies. During this phase it will be imperative to maintain fire security inside and outside the aircraft and this may entail the periodic reapplication of the foam blanket. Additionally, there may be a requirement to ventilate the fuselage to remove smoke and other toxic material providing a more survivable atmosphere and for rescue operations. Activities in the area must be coordinated by the on-scene commander.

12.3.3 A precautionary blanketing of the fuel covered area will be a priority task for the first arriving RFF vehicle(s).

12.3.3.1 Protection must be available when opening doors and windows of aircraft evacuation to guard against and maintain escape paths in the event there is a sudden outbreak of fire.

12.3.3.2 Consideration should be given to what tools and specialized equipment should be carried on the RFF vehicle(s).

12.3.4 Foam provides the capability to knock down the fire and to give a measure of post-control stability which is not provided by dry chemical powders. At category 1 and 2 airports, the foam could be contained in a pressure vessel as a pre-mixed solution and expelled by compressed gas which avoids the need for a pump. The system must be capable of discharging for at least one minute. The crew for the first vehicle of a multi-vehicle response should be proficient enough to ensure the operation of the fire suppression equipment and to provide assistance with evacuation.

12.3.4.1 With the arrival of additional vehicles, the crew of the first vehicle will become available to assist in other duties. Operational experience indicates that there are three main requirements once the major fire situation has been controlled or the critical area around the aircraft has been secured. These are:

a) Entry of rescue teams. Each team usually consisting of two firefighters to assist occupants from the aircraft. As no two accidents present the same problems, members of a rescue team must be

trained to operate both singly and as a team. They should be equipped to extricate trapped persons and to conduct all of their operations with due regard to the preservation of evidence which may be of significance in any post-accident investigation. It may be necessary to provide respiratory protection and communications equipment in the initial stages of the rescue operation;

b) to provide firefighting equipment within *the aeroplane* capable of extinguishing or cooling cabin trim and furnishing materials which may have become involved. Water-spray equipment has been found to be the most effective medium for this task; and

c) to provide lighting and ventilation equipment within the aircraft.

12.3.5 These three tasks are not specified in order of priority and if a fire situation exists within the aircraft it will be essential to control this before any other operation can be commenced. Similarly, if there is no fire but trim and upholstery materials are decomposing because of residual heat the decomposition must be stopped by the use of water-spray and the environment made habitable by natural or induced ventilation.

12.3.6 *Post-accident ventilation.* In aircraft accident situations, where a fire situation has been controlled or extinguished, the interior of the aircraft may be filled with smoke or the bi-products decomposing materials. It is important to create a survivable atmosphere within the aircraft as soon as is practicable, to protect any occupants who may be unable to escape and to facilitate search and rescue operations by RFF personnel. Smoke and fumes will impair vision, make movement difficult and may rapidly prove fatal to all occupants. If making entry into aircraft, self-contained breathing apparatus (SCBA) should be worn; ventilation of the aircraft is the only satisfactory means of creating a survivable atmosphere.

12.3.7 *Ventilation* can be achieved by removing the smoke or fumes which are unacceptable or by admitting fresh air which will displace the smoke or fumes to progressively improve the environment. For either of these methods it would, in suitable circumstances, be possible to use natural ventilation, by opening the doors and windows of the aircraft on the upwind and downwind sides, thus permitting a flow of air through the aircraft. The movable portions of flight deck windows can also be used provided that the door to the flight deck is kept open. The limitations of natural ventilation are that there may be smouldering materials outside the aircraft on the upwind side which will contaminate the airflow to the aircraft. A similar situation may arise where there are fuel-contaminated surfaces on the upwind side or where concurrent fire suppression activities are employing dry chemical powder or vaporizing liquid agents.

12.3.8 *Mechanically-induced ventilation can overcome* these problems in most cases. A suitably designed unit can be sited at a point where it receives clean air which is then delivered to the aircraft. Portable fans (smoke ejectors) may be carried on RFF vehicles. There are several types of equipment which may be used for mechanically induced ventilation, including exhaust or ejector devices, some driven by electric motors or gasoline-powered engines. Some of these have to be suspended in doorways or at windows by means of an adjustable bar.

12.3.9 Whenever ventilation is introduced, there will be the risk of promoting fire in any smouldering materials within the aircraft or at any point external to the aircraft where there is an accelerated airflow. Personnel equipped with charged hose lines terminating in hand-controlled water-spray nozzles must be available to meet any sudden outbreak of fire.

12.3.10 *Rescue equipment requirements.* In reviewing the equipment required for use by rescue personnel, based on the operational duties discussed above, the following items should be available:

a) Lighting equipment, preferably operating from a portable generator and serving one or more pieces of lighting apparatus. The requirement for illumination will include both area lighting

(flood lights) and smaller units to be employed at working locations. Caution should be used when operating portable power sources in a fuel vapour atmosphere and when operating with electricity in a wet environment.

- b) Power-operated tools, capable of being operated from a portable power source. The form of power to be used is a matter for local determination but ideally a common source should serve all powered tools, including a rotary saw for major cutting and a reciprocating saw or percussion operated chisel for more precise cuts, including those which may be made close to a trapped person. The provision of alternative cutting devices or the use of a vehicle-mounted power source is not excluded provided any alternative offers equivalent operational facilities; There are an array of battery powered hand tools available today.
- c) Hand tools, including wire and bolt cutters, screw-drivers of appropriate sizes and designs, crowbars, hammers and axes. The full extent of a hand tool requirement must be related to the types of aircraft operating and the availability of trained support personnel. Nevertheless, the hand tools have some value in appropriate cases and should not be ignored in training period;
- d) Forcing equipment, usually hydraulically operated, for bending, lifting or cutting operations. It is usual to employ adapted industrial kits which can be assembled from a selection of components to provide a variety of lengths of tubular shaft on which the hydraulic ram attachment may exert a force;
- e) Respiratory protection, which may consist of an SCBA;
- f) Communications equipment, telephone(s), radio(s) operating on the frequency allocated to the airport RFF service. These units should provide two-way communication between:
  - 1) All other required emergency vehicles;
  - 2) Air traffic control;
  - 3) The common traffic advisory frequency when air traffic control is not in operation or there is no air traffic control;
  - 4) Between RFF service and flight crew, where this arrangement has been established; and
  - 5) Fire stations, where specified in the airport emergency plan (mutual aid).

Even though not a two way communication, a hand-held megaphone would also be valuable, particularly in crowd control situations and directing personnel evacuating the aircraft:

- g) miscellaneous items, including wedges, plugs for fuel lines, shovels, grab-hook or pike-pole, lines (cordage), and ladders of appropriate type and length, related to the aircraft in use;
- h) charged hand-line;
- i) equipment capable of delivering a fresh air supply; and
- j) medical first aid equipment, ideally consisting of prepackaged wound dressings in protective containers, scissors, adhesive dressings and burn dressings. Included in this category may be foil blankets and carrying sheets. Stretchers are difficult to handle in confined spaces but the provision of spine boards may be of value in handling seriously injured persons.

12.3.11 *Coordination of flight crew members and RFF personnel.* The purpose of this guidance material is to reduce confusion on the part of all personnel concerned in the handling of aircraft accidents or incidents on or near an airport. To this end, it is necessary to bring about a better understanding between crew members and rescue and RFF personnel.

12.3.12 During an aircraft accident or incident the crew members' efforts are directed towards a common goal, i.e. safety of all occupants of the aircraft. Where an incident occurs in flight requiring the pilot-in-command to declare an emergency, the commander will in all probability state the nature of the incident, e.g. power plant fire, bomb threat, cabin fire, etc., and a plan for coping with the incident.

12.3.13 Normal evacuation routes may include over wing exits and available doors;—The use of over wing exits presents hazards if the aircraft is in the normal position with gear extended or collapsed. The distance to the ground from the wing surfaces may be excessive and cause serious injury to those evacuating from the aircraft. Leading edge wing evacuation should be considered where fire may block the normal evacuation off the trailing edge of the wings. It is recommended that only the aircraft doors equipped with stairs or slides be used where immediate life safety is not a factor.

12.3.14 Annex 6, Part I, requires that operators of aircraft ensure that each of their pilots is familiar with the regulations and procedures of, among others, the airports to be used. Additionally, all crew members are trained in and assigned specific duties to perform in cases of an aircraft accident or incident, including emergency evacuation of aircraft occupants and directing them to a safe distance from the scene of the accident or incident. As a result of the Annex 6 requirement, aircraft and airport operators should endeavor to achieve the highest possible understanding on RFF capabilities and procedures. Personal contact should be encouraged between all personnel concerned (crew members and RFF personnel) to achieve this.

12.3.15 Crew members and RFF personnel should be aware of the dangers associated with the indiscriminate opening of doors or emergency exits which might permit entry of flames or toxic gases into the fuselage of the aircraft.

12.3.16 Aircraft are normally equipped with emergency exit devices (i.e. slides, rope, etc.), in addition rescue personnel may want to include a vehicle with stairs in the event the normal evacuation devices fail to operate or for RFF personnel to enter the aircraft.

12.3.17 Crew members are trained in the use of emergency evacuation slides provided at normal and emergency exit doors to assist in the rapid evacuation of passengers. Where these slides are provided and are in use when RFF personnel arrive, air crew members should not be disturbed unless the slides have been damaged by use or fire exposure. In the latter case, ladders or emergency stairs, provided by the RFF personnel should be placed into immediate service.

12.3.18 The use of emergency evacuation slides will usually provide a much more rapid evacuation than conventional steps or stairs where speed of evacuation is mandatory. It is preferable to use the aircraft equipment. RFF personnel should stand by at the foot of the slides to aid exiting persons to their feet and direct them to a staging area a safe distance from the scene.

12.3.19 Evacuees using over wing exits for evacuation will normally slide off the rear edge of the wing or down the wing flaps (if extended), and they should be given assistance to prevent leg injuries, then directed to a safe distance from the scene.

12.3.20 In order to coordinate better evacuation procedures, it is often desirable to establish direct

contact with the flight crew members. Most airport emergency equipment carries two-way radios, operating on ground control frequency. Prearrangement with the control tower will ensure that the aircraft changes to this frequency, if time and the nature of the emergency permit.

12.3.21 The responsibilities of flight crew members and airport emergency personnel should be clearly defined and under all conditions the prime concern must be directed to the safety of those persons aboard the aircraft. In many cases, this will necessitate emergency evacuation procedures under various types of conditions. Duties and responsibilities can be generally defined as follows:

- a) **Crew members.** Since conditions and facilities differ greatly on most airports, crew members must remain primarily responsible for the aircraft and its occupants. The final determination to evacuate from the aircraft and the manner in which evacuation shall be carried out must be left to the discretion of the crew, provided they are able to function in a normal manner.
- a) **RFF personnel.** It will be their duty and responsibility to assist the air crew in any way possible. Since air crew visibility is restricted, RFF personnel should make immediate appraisal of the external portion of the aircraft and report unusual conditions to the air crew. Protection to the over-all operation is the primary responsibility of the RFF personnel. In the event air crew are unable to function, the RFF personnel will be responsible for initiating necessary action.

12.3.22 **Communications.** RFF personnel should take immediate steps to establish direct contact between the pilot and on scene commander. This will ensure all factors are properly considered before actions are initiated. Several methods of providing this direct communication are generally available:

- a) **Radios.** The success of an effective aircraft intervention incident may depend on the transmission and reception of clear, concise and understandable communications at all levels. Clearly communicated information reduces confusion and helps to maximize the use of available resources. Each aerodrome should establish a standard operating procedure (SOP) for emergency communications. These communications should be coordinated with other mutual air partners who may provide assistance to the aerodrome. These procedures should include defined lines of communication, and specified frequencies. Two-way radio is an effective means for communicating with RFF personnel during an aircraft incident/accident. Radios should have sufficient channels to allow the necessary command and support functions to operate on separately. The Incident Commander should have the ability to communicate with other agencies on separate frequencies during the incident/accident.
- b) **Aircraft intercom.** Where aircraft engines are running it may be difficult to communicate with the pilot by radio from near the aircraft. Most aircraft are equipped with “intercom” systems where “jacks” are generally located under the forward portion of the aircraft, behind an access door. RFF personnel should be aware of this means of communication and carry the necessary head-set and microphones to plug into these facilities. Even with the engines running, proper direct communications with the pilot can be established by use of this system.
- c) **Other communication means.** Where other means of communication cannot be established, it is advisable for the officer-in-charge of the RFF personnel report to the left side of the aircraft nose and establish direct voice communication with the pilot or flight crew. Portable amplifiers may prove valuable for this type of communication. It may be necessary to resort to hand and arm signals to relay the information. Figure 12-1 shows the signal which may be used by RFF personnel to advise the pilot to cut engines. Information on other marshalling signals is contained in Annex 2 — *Rules of the Air*.

12.3.23 **Aircraft fire warnings.** Since it is often impossible for the crew members to make an accurate appraisal of aircraft fire warning indicators, it is advisable to bring the aircraft to a complete stop and

allow the RFF personnel to inspect the area involved, prior to parking. This inspection can usually be greatly enhanced by the use of thermal imaging equipment without having to open aircraft compartment doors.

12.3.24 **Engines running.** It may be necessary to keep at least one engine operating after the aircraft has come to a stop in order to provide lighting and communications aboard the aircraft. This will hamper rescue operations to some extent and consideration should be given to this problem. On reciprocating and turbo-propeller engines extreme care must be exercised by personnel on the ground to remain clear of the propeller arc. On turbo-jet engines extreme care must be exercised in the immediate area ahead and for a considerable distance behind the engine.

12.3.25 **Equipment positioning.** Wind conditions, terrain, type of aircraft, cabin configurations and other factors dictate approaches. For this reason, it is necessary for flight crew members to inform RFF personnel of the details regarding the particular aircraft in question. On combined cargo-passenger aircraft, the airport emergency crews should be notified of cabin configurations, since some cargo areas extend as far aft as the over wing exits, making them unavailable for emergency evacuation.

12.3.26 Tactical decision-making starts at the time when the alert tone is sounded and continues to be made both while enroute and during initial approach to the scene. Size-up (what is happening / what is about to happen / what needs to be done) and correct tactics will need to be implemented without delays. A tactical plan for positioning RFF vehicles for various aircraft applicable to that aerodrome should be documented, known to RFF personnel and practiced as part of an ongoing training program. As part of the size-up process the Incident Commander would decide whether or not the tactical plan would need to change. RFF apparatus and other responding vehicles must be positioned correctly if RFF operations are to be successful. Because RFF apparatus often respond single file, the first fire apparatus to the accident site often establishes the route for other vehicles and may dictate the approach into their ultimate positions. In positioning apparatus, first-arriving crews and the incident command should follow certain guidelines:

- a) Approach the scene with extreme caution. Watch for evacuating occupants, wreckage debris, fuel ponding, and other hazards. Avoid driving through any smoke which obscures your vision and potential evacuee's. Avoid driving over any aircraft wreckage.
- b) Terrain and slope of the ground should be considered, direction of the wind prior to entering a crash site. You should attempt to position vehicles uphill and upwind to avoid fuel and vapors which tend to gather in low-lying areas.
- c) Do not block the entry or exit areas which emergency vehicles may need to use.
- d) Initial position of vehicles should be to protect egress routes of evacuating aircraft occupants.
- e) Ideally vehicles should be positioned so they can be repositioned in the event of reflash or on direction of the incident commander.
- f) Vehicles should be positioned so turrets can cover maximum amount of the aircraft fuselage.
- g) The Incident Commander should consider what is happening, what is about to happen and what to do to preserve life and property.
- h) Consideration shall be given to preservation of accident site.

12.3.27 **Evacuation.** As previously stated, the final determination regarding evacuation from the aircraft must be made by the pilot in command with input from the RFF incident commander.

12.3.28 An unnecessary evacuation may be prevented by RFF personnel communicating with the flight crew on the appropriate frequency and giving the flight crew a report on exterior conditions. Remember, once an evacuation is initiated it cannot be stopped. Most engines, wheel assembly, and other minor exterior emergencies, can be controlled by RFF personnel, without threatening the aircraft occupants

requiring an evacuation. An unnecessary evacuation can endanger and injure the evacuees. The decision to evacuate is always ultimately the call of the pilot in command. RFF personnel should not impede the evacuation and should not attempt to enter the fuselage but instead provide assistance and be prepared to assist those not capable of self-evacuation.

12.3.29 Nearly all aircraft are equipped with emergency evacuation equipment and the crew members should be competent in the use of this equipment. Some of the RFF personnel carry emergency aircraft evacuation stairs and in such cases, the crew members should be informed of the availability of these stairs. Where evacuation slides are in use, they should not be disturbed unless they are damaged. If they have not been activated, or if they have been damaged, evacuation stairs should be placed in use. These stairs could also prove beneficial in evacuation off wing surfaces where the distance from the wing to the ground is excessive.

12.3.30 Normal evacuation routes may include both over wing window exits and available doors. The use of over wing exits presents hazards if the aircraft is in the normal position with gear extended or collapsed. The distance to the ground from the wing surfaces may be excessive and cause serious injury to those evacuating from the aircraft. Leading edge wing evacuation should be considered where fire may block the normal evacuation off the trailing edge of the wings. It is recommended that only the aircraft doors equipped with stairs or slides be used where immediate life safety is not a factor.

## 12.4 ACCIDENTS INVOLVING DANGEROUS GOODS

### *General*

12.4.1 Dangerous goods are frequently carried in commercial transport aircraft, on both passenger and cargo flights. The types of dangerous goods which are permitted for carriage, and the conditions under which they may be carried, are explained in the ICAO *Technical Instructions for the Safe Transport of Dangerous Goods by Air* (Doc 9284) which, pursuant to the provisions of Annex 18 — *The Safe Transport of Dangerous Goods by Air* are to be applied by all Contracting States. Reference should be made to the Technical Instructions for full details on the transport of dangerous goods by air.

12.4.2 Dangerous goods shipments by civilian aircraft are regulated by the Code of Federal Regulations (CFR) Title 49, Part 175, *Carriage by Aircraft*, in the United States and by the International Air Transport Association (IATA) regulations for international shipments. The IATA regulations are based upon the "Technical Instructions for the Safe Transportation of Dangerous Goods by Air", published by the International Civil Aviation Organization (ICAO). Dangerous goods may be shipped within the United States following IATA regulations instead of Title 49.

12.4.3 While thousands of chemicals are considered to be hazardous if released from their containers, those chemicals considered hazardous in transport are listed in Table 172.101 in Title 49. This table also provides information concerning reportable quantities (RQ) of dangerous goods. Transportation of dangerous goods by air is highly regulated, consult applicable regulations for a list of dangerous goods that can be and are shipped by air.

12.4.4 Under the provisions of the Technical Instructions, certain types of dangerous goods presenting extreme hazards are forbidden from transport by air under any circumstances. Other less dangerous varieties, although normally forbidden for transport by air, may be transported under certain conditions under the terms of an "exemption", but only with the specific approval of all States concerned (i.e. States of origin, transit, destination and over flight). Of those types of dangerous goods normally permitted to be transported by air, only those of a relatively limited degree of hazard by air, only those of a relatively



limited degree of hazard are permitted aboard passenger aircraft with the remaining, more dangerous goods, restricted to transport aboard cargo aircraft only.

*Dangerous goods defined*

12.4.5 Dangerous goods are articles or substances which are capable of posing significant risk to health, safety or property when transported by air. For the purposes of air transport they are divided by the Technical Instructions into nine classes reflecting the type of hazard they present to transport workers and emergency response personnel.

12.4.6 The nine classes of dangerous goods are:

Class 1	Explosives
Class 2	Gases: compressed, liquefied, dissolved under pressure or deeply refrigerated
Class 3	Flammable liquids
Class 4	Flammable solids; substances liable to spontaneous combustion; substances which, in contact with water, emit flammable gases
Class 5	Oxidizing substances; organic peroxides Class
Class 6	Poisonous (toxic) and infectious substances
Class 7	Radioactive materials
Class 8	Corrosives
Class 9	Miscellaneous dangerous goods: that is, articles or substances which, during air transport, present a danger not covered by other classes. Examples: magnetized material; acetaldehyde ammonia; expandable polystyrene beads and lithium batteries.

*Note.— The order in which these classes are listed does not imply a relative degree of hazard.*

12.4.7 In some classes, dangerous goods are further divided into divisions. The division is expressed by placing a decimal point after the class number and reflecting the number of the division, i.e. Division 6.1. In these cases, reference is made only to the division and not to the class, e.g. Division 5.2, not Class 5, Division 2.

*Communication of hazards presented by dangerous goods*

12.4.8 As a condition for transporting dangerous goods by air, the Technical Instructions prescribe certain actions that must be taken to advise transport workers and emergency response personnel of the hazards presented by the dangerous goods transported. These hazards are communicated principally through markings and labels applied to the package of dangerous goods and through the provision of certain information in transport documents that accompany a shipment.

12.4.9 *Package markings and labels.* Packages of dangerous goods are required to be marked with the “proper shipping name” of the dangerous goods, as listed in the Technical Instructions, and with the

corresponding 4-digit “United Nations (UN) number”, used to identify the substance. The package is also required to bear one or more hazard labels. These labels are in the form of a 100 mm × 100 mm square on point, with a distinctive symbol and colour. These package markings and labels enable emergency response personnel to immediately recognize the nature of the hazards presented by any dangerous goods that may be encountered.

12.4.10 *Transport documentation.* The Technical Instructions require that when dangerous goods are offered for transport the shipper must provide to the operator a transport document which contains certain information relative to the dangerous goods. The information required includes the proper shipping name, hazard class or division number, UN number and subsidiary risk of the goods. From this document, the operator prepares a notification to pilot-in-command that provides the information relative to the hazards of the dangerous goods aboard the aircraft to the pilot as well as the location in the aircraft where the dangerous goods have been loaded. The notification to pilot-in-command must be provided to the aircraft commander as early as practicable before departure and must be readily available in flight.

12.4.11 *Information by pilot-in-command in case of in-flight emergency.* If an in-flight emergency occurs, the pilot-in-command should inform the appropriate air traffic services unit, for the information of aerodrome authorities and RFF services, of any dangerous goods on board. If the situation permits, the information provided should include the proper shipping names, class and subsidiary risks, the compatibility group for Class 1 and the quantity of each type of dangerous goods as well as the location where they are stowed aboard the aircraft. If a lengthy message is impossible, the dangerous goods on board may be identified by transmitting the UN numbers.

#### *Emergency actions*

##### *Fires*

12.4.12 *General.* Many types of dangerous goods (e.g. flammable liquids) would be consumed in large aircraft fires and consideration of the possible types and amount of cargo aboard an aircraft suggests a potential for an even greater hazard. RFF personnel should use proper procedures in response, scene size-up/assess the situation, and operations to ensure they are protected from the effects of dangerous goods. As with any fire, however, personal protective clothing, including breathing apparatus (as a minimum), should always be worn. As far as possible, RFF personnel should stay position upwind and out of smoke, fumes and dust.

12.4.13 On cargo-carrying aircraft, hazardous freight is usually placed in *unit load devices*; which are aircraft containers, aircraft pallets, which may be secured with a net. These containers are then loaded aboard the aircraft. Some air carriers use specially modified unit load devices for transporting certain dangerous goods on the main deck of freighter aircraft. These containers may have special colors and include an integral fire suppression capability. (Unit load devices containing dangerous goods will have a small tag wired to the outside or placed in a plastic window, indicating which of the nine hazard classes, previously listed, are shipped inside. The tag will usually have a red “red striped” border. Special discharge nozzles located inside the container are coupled to a portable extinguisher by a connection on the exterior of the unit. Flight personnel can manually discharge extinguishing agent into the container without having to open it. Certain dangerous goods must be accessible to the crew in flight in case of a leak or fire. As a general rule, most dangerous goods on the main deck of cargo aircraft are loaded in the most forward location.

12.4.14 *Explosives.* The types of explosives normally permitted aboard passenger or cargo aircraft would be classified in Division 1.4. By definition, this division is comprised of explosive articles or substances which present no significant hazard in the event of accidental ignition or initiation during transport. The effects are largely confined to the package (unless the package has been degraded by fire)

and no projection of fragments of appreciable size or range is to be expected. An external fire should not result in an instantaneous explosion of virtually the entire contents of the package.

12.4.14.1 The only type of explosives normally permitted aboard passenger aircraft are those classed in Division 1.4, Compatibility Group S. These are explosives for which, even when the package is degraded by fire, blast and projection effects are limited to the extent that they do not significantly hinder firefighting or other emergency response efforts in the immediate vicinity of the package. Where circumstances permit, an effort should be made to ascertain the classification of any explosives aboard an aircraft, e.g. through information provided by the crew (see 12.4.9), since in certain cases explosives of other than Division 1.4 which could pose a risk of mass detonation in a fire, may be carried under an exemption issued by the States concerned. ICAO Dangerous Goods Manual (Doc 9284) will identify which dangerous goods can only be shipped on cargo aircraft & which can be shipped on both cargo & passenger aircraft. Materials that can only be shipped on cargo aircraft will have “cargo aircraft only” labels on the shipment. RFF personnel should be familiar with local air cargo loading procedures.

12.4.15 *Gases.* Cylinders of compressed or liquefied gases may present a risk of explosion if involved in an aircraft fire. However, as these cylinders are normally constructed to standards similar to those to which oxygen or air cylinders installed in aircraft are constructed, pose a significant risk if they rupture or are exposed to direct fire contact.

12.4.16 *Flammable Liquids.* Flammable liquids include liquids or mixture of liquids, liquids containing solids in solution or in suspension that give off a flammable vapour at temperature of not more than 60.5°C. Typically, flammable liquids will cause bigger fire than flammable gases as they are more concentrated. The vapours of many flammable liquids are also usually heavier than air and most of such liquids will float in water. Methods used to extinguish fires involving jet fuel can be similarly used for flammable liquid.

12.4.17 *Flammable Solids.* Flammable solids refer to all solids and substances which are liable for spontaneous combustion, or substances which emit flammable vapours on contact with air, moisture or water, which may lead to fire or explosion. As most of these materials may react violently with water or air, RFF personnel must be cautious when using water as an extinguishing agent.

12.4.18 *Oxidizing Substances, Organic Peroxides.* Oxidizing substances are not necessarily combustible, but may generally cause or contribute to the combustion of other material. Organic peroxides are thermally unstable and may undergo exothermic (and explosive), self-accelerating decomposition. They are sensitive to heat, shock, impact or friction, and react dangerously with other substances, i.e. may cause an explosion when mixed with jet fuel.

12.4.19 *Poisonous (toxic) and Infectious Substances.* Poisonous (toxic) substances are liquids or solids which are known to be liable to cause death if swallowed, inhaled or contacted by the skin. Infectious substances are materials that may cause disease in humans or animals, and include microorganisms and organisms, biological products, diagnostic specimens, and medical waste. Some of these substances may burn, but they do not ignite easily. If these substances are present at the scene of fire, it is advisable to fight the fire from a maximum distance as it is more of a health hazard rather than a fire hazard.

12.4.20 *Radioactive materials.* Fires involving radioactive materials should be handled in the same manner as fires involving toxic materials. Standard protective clothing and respiratory protection provides some protection against radioactive contamination but not, however, from some direct radiation effects. Fires and the air currents they create, and the use of foam, water or chemicals to suppress fire, can spread radioactive materials about the accident site. RFF personnel entering and working in an aircraft incident scene or impact area should be utilizing the appropriate personal protective equipment (PPE) and receive

the appropriate level of decontamination immediately after their duties are completed.

12.4.20.1 In the event radioactive materials are suspected, the following general procedures should be followed:

- a) the nearest authority concerned with atomic energy or the nearest military base or civil defense organization to the accident site should be notified immediately. They may be able to respond to the accident with a radiological team;
- b) injured persons should be wrapped in blankets or other available covering (to reduce the possible spread of contamination) and immediately transported to medical facilities with instruction to the drivers or attendants that the injured persons may be radioactively contaminated and that they should so inform medical facility personnel who are to care for them;
- c) other persons who might have had possible contact with radioactive material should be sequestered until they have examined by radiological teams;
- d) suspected material should be identified but not handled until it has been monitored and released by radiological emergency teams. Clothing and tools used at the accident scene should be retained in isolation until they can be checked by a radiological emergency team;
- e) food or drinking water that may have been in contact with material from the accident should not be used;
- f) only properly attired RFF personnel should remain on the scene; all other persons should be kept as far away from the scene as possible;
- g) all hospitals shall be notified immediately that radioactive materials are involved so that appropriate radioactive decontamination areas may be established; and
- h) packages of radioactive material should be cordoned off; any loose materials should be covered with plastic sheets or tarpaulins to minimize dispersion by wind or rain.

12.4.21 Corrosives. Substances that are grouped in this class may in their original state, damage living tissues severely. These corrosives can also release vapour that may irritate the nose and eyes. A few of these substances may produce toxic gases when decomposed by very high temperatures. Some corrosives are also toxic and may result in poisoning if swallowed. Corrosives are usually acids or alkalis, which can be water reactive, flammable (for organic acids), very reactive and unstable oxidizers. PPE should be worn by all RFF personnel when these substances are present at the scene of fire.

12.4.22 Miscellaneous Dangerous Goods. This comprises substances and articles which present a danger not covered by other classes. It includes a number of substances and articles which present a relatively low hazard, such as environmental pollutants. Examples of these substances are dry ice, molten sulphur, polychlorinated biphenyls, batteries containing lithium, magnets, etc.

#### 12.4.23 *Spills and leaks*

12.4.23.1 *General.* Dangerous goods packages not consumed in, or affected by an aircraft fire may be found damaged and leaking at an accident site. Such damaged and leaking packages may pose a significant risk of injury or adverse health effects to aircraft occupants and RFF personnel. Hazard labels

and package markings (see 12.4.7) can be of assistance in identifying the types of dangerous goods involved as well as the nature and seriousness of the hazard they present. Once initial rescue operations are completed, special precautions should be taken with such packages and, if necessary, pre-identified trained personnel assembled to deal with the problems involved. Particular problems may be encountered with radioactive materials (Class 7) and poisonous and infectious (Class 6) substances.

12.4.23.2 *Poisonous and infectious substances.* In the event of an occurrence involving poisonous or infectious substances, food or drinking water that may have been in contact with the material should not be used. The public health and veterinary authorities should be informed immediately. Any person exposed to these dangerous goods should be removed from the scene of the occurrence and transported for decontamination as soon as possible to the appropriate medical facilities.

12.4.23.3 *Additional information.* A number of publications are available that provide more detailed guidance to fire departments and other interested agencies relative to actions to be taken in response to accidents or incidents involving dangerous goods. The ICAO publication *Emergency Response Guidance for Aircraft Incidents involving Dangerous Goods* (Doc 9481) provides information intended for use by aircraft crews during in-flight dangerous goods emergencies. For accidents or incidents occurring on the ground, the *Emergency Response Guidebook* published by the United States Department of Transportation, Washington, D.C., and the *Response Guide for Dangerous Goods* published by Transport Canada, Ottawa, are particularly useful.

#### *Unlawful interference*

12.4.24 An aircraft which is subjected to a threat of sabotage or unlawful seizure should be parked at an isolated aeroplane parking position located on an area at least 100 m away from other aircraft parking positions, buildings or public areas until the act of unlawful interference is terminated. In such cases it may be necessary to evacuate passengers without the use of loading ramps provided at the passenger terminal. Motorized loading ramps may be available which could be driven to the site, or emergency evacuation stairs or the aircraft's slides could be used. Detailed information on procedures for dealing with unlawful interference is given in the ICAO Security Manual.

12.4.25 *Chemical, biological and radioactive threats (unknown substances).* Although all dangerous goods are required to be clearly labeled and packed, there could be scenarios where substances are unknown and that they may be unlawfully released in an aircraft or within the aerodrome premise. For RFF personnel who may need to identify unknown substances, RFF services may want to equip themselves with the basic equipment to detect the nature of such substances. These include any chemical, biological or radioactive detectors.

## **12.5 POST-ACCIDENT PROCEDURES**

12.5.1 Rescue units should familiarize themselves with all regulations, national and local, regarding movements of wreckage and disposal of human remains and the preservation of evidence. It is also important to understand the techniques and procedures used in aircraft accident investigation. After fire suppression and survivor rescue have been completed, the following procedures should be observed.

12.5.2 Removal of bodies of fatality injured occupants remaining in wreckage after the fire has been extinguished or controlled should be accomplished only by or under the direction of responsible medical authorities. Premature body removal has, in many cases, interfered with identification and destroyed pathological evidence required by the medical examiner, coroner or authority having investigational jurisdiction.

12.5.3 If extrication of casualties from aircraft wreckage is necessary, the position and seat number in which the survivors were located in the aircraft should be recorded at the earliest opportunity. Where casualties are located at positions away from the wreckage, the positions should be marked by a stake with a label identifying the victim and the seat. In all cases the casualties should have an identifying label attached to them stating where they were found and in which seat. Similarly, personal belongings should remain attached. Apart from gaining information which may assist in the accident investigation, the careful recording of all these data may assist in the identification of casualties.

12.5.4 If circumstances permit, the area should be photographed for future reference prior to any body removal activity. Photographs are advantageous tools to aid investigators and should be given as soon as practicable to the appropriate agency having responsibility for the accident investigation. To this end, it may be desirable to appoint a RFF photographer so that the scene can be photographed for future accident investigation purposes.

12.5.5 The wreckage of an aircraft involved in an accident, including controls, shall not be disturbed (moved) until released for removal by the investigational authority having jurisdiction. If the aircraft, parts, or controls must be moved because they directly present a hazard to human life, efforts should be made to record their original condition, positions, and locations, and due care should be afforded to preserve all physical evidence. If circumstances permit, photographs should be taken showing the location and position of all major components marked on the ground. Details on removal of disabled aircraft can be found in the *Airport Services Manual* (Doc 9137), Part 5. — *Removal of Disabled Aircraft*.

12.5.6 On completion of the initial rescue operation, it is important that the RFF personnel exercise as much care as possible to ensure their movements do not destroy evidence which may be of value in the investigation. For example, movement of ambulance and RFF vehicles should not be made along the wreckage trail if alternative access is possible.

12.5.7 The location of mail sacks and pouches should be observed and this information given to postal authorities. If necessary, the mail should be protected from further damage.

12.5.8 Aviation fuels and hydraulic fluids may cause dermatitis by contact with the skin. RFF personnel who have had these fluids spilled on them should be washed thoroughly with soap and water as soon as possible. Wet clothing and uniforms should be changed and decontaminated promptly.

## Chapter 13

### RESCUE OPERATIONS IN DIFFICULT ENVIRONMENTS

#### 13.1 GENERAL

13.1.1 At airports where a significant proportion of aircraft arrivals and departures takes place over water, swampy areas or other forms of difficult terrain in the immediate vicinity of the airport and where conventional RFF vehicles may not be capable of an effective response, the airport or appropriate authority should ensure the availability of special procedures and equipment to deal with accidents which may occur in these areas. These facilities need not be located on, or be provided by, the airport if they can be made immediately available by off-airport agencies as part of the airport emergency plan. In all cases the airport or appropriate authority must determine and specify in advance the response area for which it undertakes to provide a rescue service.

13.1.2 In producing its detailed plan the airport or appropriate authority should have regard to the services and facilities already provided by the search and rescue organization in accordance with 4.2.1 of Annex 12, to ensure that the separate responsibilities for an aircraft accident in the vicinity of the airport are clearly delineated. All operations, and any exercises conducted to test operational efficiency, should involve the relevant rescue co-ordination centre, to ensure the effective mobilization of all resources. Matters dealing with services and facilities necessary to provide practical and economical search and rescue coverage of a given area are described in the *Search and Rescue Manual* (Doc 7333), Part 1. — *The Search and Rescue Organization*.

13.1.3 The objectives of each operation must be to create conditions in which survival is possible and from which the total rescue operation can succeed. This concept anticipates that the initial, rapid response attendance may have to provide a preliminary level of succour while awaiting the arrival of a larger rescue force. The first stage would have as its objective the removal of immediate hazards to survivors, their protection, including the first-aid treatment of injuries, and the use of communications equipment to identify the locations to which additional rescue forces must respond. The emphasis will be on rescue and need not include any firefighting capability.

If a fire situation has occurred in the impact stage of an accident the inevitably extended response times of the first vehicles are likely to preclude effective firefighting operations. The scale of provision of rescue equipment should be related to the capacities of the larger aircraft using the airport. Typical capacities of passengers are provided in the aircraft diagrams in the websites of the various aircraft manufacturers referred to in Appendix 1.

13.1.4 The types of difficult terrain for which special rescue facilities may be required will include:

- a) the sea or other large bodies of water adjacent to the airport;
- b) swamps or other similar surfaces, including the estuaries of tidal rivers;
- c) mountainous areas;
- d) desert areas; and

- e) locations which are subject to heavy seasonal snowfalls.

13.1.5 The equipment to be deployed in effecting a rescue operation will vary with the environment in which the operation is to be conducted. The training required by the personnel delegated to these duties will similarly reflect the terrain conditions. In all situations the basic equipment may include:

- a) communications equipment, which may include equipment for visual signals. Ideally the use of a transmitter on the distress frequency will provide a link with air traffic control and the emergency operations centre;
- b) navigation aids;
- c) medical first aid equipment;
- d) life-support equipment, including life-jackets in marine situations, shelter, foil blankets and drinking water;
- e) lighting equipment; and
- f) lines, boat hooks, loudhailers and tools, e.g. wire cutters and harness knives.

13.1.6 The types of vehicle available for rescue operations in difficult terrain will include:

- a) helicopters;
- b) hovercraft;
- c) boats, of a number of types and capacities;
- d) amphibious vehicles;
- e) tracked vehicles; and
- f) all-terrain vehicles, including those employing ground-effect to minimize wheel-loadings.

13.1.7 In most States the more complex forms of vehicles are already in service with military formations or other forms of security organizations, from which valuable operational performance data may be available. Some of the more obvious factors relating to each type of vehicle are discussed below.

- a) *Helicopters.* The variety of helicopters now in general service offer a range of emergency options, dependent on the capacity, endurance and operational limitations of each type. The larger helicopters, with trained crews specializing in rescue operations, are most often deployed by military agencies and may be available in emergencies to civil airports. For successful liaison with helicopters, in operations on land or in the water, a communications link is essential, with control of the surface facility under the direction of a person familiar with the operational requirements of helicopters. This will reduce the hazard to the helicopter, particularly at night, from obstructions and the movement of vehicles and personnel at the accident site. Helicopters can be used to drop life rafts and other flotation devices in marine situations and other forms of life-support equipment in land-based accident situations. Where an aircraft accident has occurred in the water and a large number of survivors maybe at risk it will be essential to have personnel, with life rafts or dinghies, at the surface, where the survivors may require assistance to reach a safe location before final rescue can take place. It may therefore be necessary to link any



helicopter rescue effort with a simultaneous surface operation. It should also be noted that the downwash from helicopters can cause serious distress to survivors in the water by creating turbulence. The use of helicopters as airborne control positions or as a source of floodlighting can be advantageous. The cost involved in housing, operating and maintaining a continuously-available rescue helicopter may preclude its provision as an airport facility but arrangements with military or commercial organizations should secure its availability in an emergency.

- b) *Hovercraft*. These offer an adaptable form of transport with operational performance, capacity and cost being related to size. The smaller hovercraft have a limited capability for clearing obstructions and when operated on water may be restricted by wave height. They also have a limited capacity for accommodating survivors but this can be offset by their ability to deliver survival equipment to an accident site. As with helicopters, the hovercraft will need a highly-trained operator and skilled maintenance personnel to maximize its operational availability and deployment. The costs of housing, operating and maintaining a hovercraft, which may need a slipway to facilitate its deployment to any tidal water surface, will be substantial.
- c) *Boats*. In selecting the type of rescue boat to be operated it will first be necessary to consider the range of water surface conditions likely to be encountered, the depth of water in the response area, any sub-surface hazard, such as rocks and coral reefs, and then the role to be accorded to each boat. The expertise necessary to make the appropriate choice will be available within each State, permitting a choice to be made from the wide range of options. These would include rigid-hulled sea-going craft, with considerable range and capacity and smaller, inflatable craft, with outboard motors, primarily intended for inshore operations. Some States have combined the inshore rescue and the search and rescue roles, providing vessels with advanced navigational equipment and major medical facilities. In other States the inshore rescue facility is provided by the airport or appropriate authority using trained RFF personnel to crew inflatable craft. These craft, mounted on trailers for rapid deployment and ease of launching, carry containers holding inflatable life rafts which can be deployed at the accident site to accommodate survivors. There are also relatively small rigid-hulled craft which achieve their propulsion by means of sub-surface water jets, thus eliminating the hazard of propellers to survivors in the water. These, too, can carry life rafts. The life rafts, once filled with survivors, are not easily towed but they can be marshalled and secured against drifting by the powered rescue craft, until additional support arrives. There will also be marine craft available from commercial sources and from private users but their acceptability in a rescue support role will be dependent on the speed with which they can be dispatched and the existence of communications which will permit their control. Random interventions, although desirable on humanitarian grounds, can create difficulties at the accident site.
- d) *Amphibious vehicles*. These are usually wheeled vehicles, relatively small in size and primarily in use by military and security forces. Their speed on water is slow and their capacity is limited. One exception to this classification, already in use at an airport as a rescue craft, is a vehicle having its propulsion provided by two longitudinal cylinders with a raised helical section. This vehicle can operate on paved surfaces, water or mud, having a hull which provides buoyancy. Within the hull there is accommodation for rescue equipment, including life rafts, and some capacity for survivors once the life rafts have been deployed. All amphibious vehicles would require a launching ramp to facilitate their entry into water as they cannot negotiate significant obstructions. As with all vehicles, they require effective maintenance, particularly in the design features which provide buoyancy.
- e) *Tracked vehicles*. These can be effective in negotiating rough ground and deep snow but

all vehicles of this type have a relatively low payload to gross weight factor. They are usually slower than wheeled vehicles of similar capacities but are superior in their ability to tow sledges over snow-covered surfaces. Some tracked vehicles are in use as rescue vehicles at airports. They require skilled maintenance to preserve their availability. A tracked vehicle can serve to convey personnel and small items of equipment to the accident site on snow-covered surfaces but is unlikely to have any other significant role.

- f) *Ground-effect vehicles.* The early studies of vehicles in this category, mainly in military and agricultural applications, showed that some reduction in wheel loadings could be achieved. The absence of production vehicles suggests that the technical problems have proved difficult to resolve. The availability of alternative solutions for soft ground operations may also have contributed to the lack of progress with this form of vehicle.

## 13.2 OPERATIONAL PROCEDURES FOR ACCIDENTS IN THE WATER

13.2.1 Where airports are situated adjacent to large bodies of water such as rivers or lakes, or where they are located on coastlines, special provisions should be made to expedite rescue.

13.2.2 In such incidents the possibility of fire is appreciably reduced due to the suppression of ignition sources. In situations where fire is present, its control and extinguishment present unusual problems unless the proper equipment is available.

13.2.3 It can be anticipated that the impact of the aircraft into the water might rupture fuel tanks and lines. It is reasonable to assume that quantities of fuel will be found floating on the surface of the water. Boats having exhausts at the waterline may present an ignition hazard if operated where this condition is present. Wind and water currents must be taken into consideration in order to prevent floating fuel from moving into areas where it would be hazardous. Care should be taken in the use of flares, flame floats or other pyrotechnics where fuel is present on the water. As soon as possible these pockets of fuel should either be broken up or moved with large velocity nozzles or neutralized by covering them with foam or a high concentration of dry chemical powders. Calm surfaces will usually present more of a problem than choppy or rough surfaces.

13.2.4 Diving units should be dispatched to the scene. When available, helicopters can be used to expedite the transportation of divers to the actual area of the crash. All divers who may be called for this type of service should be highly trained in both scuba diving and underwater search and recovery techniques. In areas where there are no operating governmental or municipal underwater search and recovery teams, arrangements may be made with private diving clubs. The qualifications of the individual divers should be established by training and practical examination.

13.2.5 In all operations where divers are in the water, the standard diver's flag should be flown and boats operating in the area should be warned to exercise extreme caution.

13.2.6 Where fire is present, approach should be made after wind direction and velocity, water current and swiftness are taken into consideration. Fire may be moved away from the area by using a sweeping technique with hose streams. Foam and other extinguishing agents should be used where necessary.

13.2.7 It should be anticipated that victims are more apt to be found downwind or downstream. This should be taken into consideration in planning the attack.

13.2.8 Where the distance offshore is within range, dacron-covered, rubber-lined fire lines can be

floated into position by divers or boats and used to supplement fire boats. In an emergency, rafts can be assembled by two persons exhaling into a section of 6 cm fire hose, coupling it to itself, folding and binding it with hose straps.

13.2.9 Where occupied sections of aircraft are found floating, great care must be exercised to not disturb their watertight integrity. Removal of the occupants should be accomplished as smoothly and quickly as possible. Any shift in weight or lapse in time may result in their sinking. Rescuers should use caution so that they are not trapped and drowned in these situations.

13.2.10 Where occupied sections of the aircraft are found submerged, there remains the possibility that there may be enough air trapped inside to maintain life. Entry by divers should be made at the deepest point possible.

13.2.11 Where only the approximate location of the crash is established upon arrival, divers should use standard underwater search patterns marking the locations of the major parts of the aircraft with marker buoys. If sufficient divers are not available, dragging operations should be conducted from surface craft. In no instance should dragging and diving operations be conducted simultaneously.

13.2.12 A command post should be established at the most feasible location on an adjacent shore. This should be located in a position to facilitate the in and out movement of water rescue vehicles.

### **13.3 ASSESSMENTS FOR ACCIDENTS BEYOND RUNWAY THRESHOLDS**

An assessment of the approach and departure areas within 1000 m of the runway threshold should be carried out to determine the options available for rescue, including suitable resources that should be provided. In considering the need for any specialist rescue and access routes, the following should be considered:

- a) the environment, in particular the topography and composition of the surface;
- b) physical hazards and associated risks that exist within the area;
- c) options for access and for RFF purposes;
- d) hazards, risks and control measures of the options for rescue;
- e) use of external services;
- f) an analysis of the advantages and disadvantages of the options;
- g) policies and procedures to define and implement practices;
- h) competence standards to match the above; and
- i) monitoring testing and review of the capability.

Aerodrome Operators and/or RFF Service (RFFS) providers should ensure the development of special procedures and availability of equipment to deal with accidents or incidents that may occur in these areas. These facilities that house this equipment need not be located on, or provided by, the aerodrome if they can be made available within reasonable time frames by off-aerodrome agencies as detailed in the Aerodrome Emergency Plan.

Where RFFS vehicles respond to accidents or incidents using the public highway, an assessment of the implications of such a response should be carried out. The following should be considered:

- a) legal requirements for vehicles and drivers;
- b) that suitable policies and procedures are in place;
- c) competence and training requirements for drivers;
- d) pre-planning of routes for suitability; and
- e) monitoring and review of such responses.

**Consideration should be given to the following:**

- a) provide direct access to the operational runway(s);
- b) designate access routes to the response area ( consider debris and casualties);
- c) maintenance of roads and access routes (including construction activities);
- d) mitigate the possibility of any public and/or private non-emergency vehicle blocking the progress of responding emergency vehicles;
- e) take into account the gross weight and maximum dimensions of the RFFS vehicle(s) expected to use them; or any other responding vehicles;
- f) that roads are capable of being traversed in expected conditions;
- g) exit/access gates or frangible sections in the security fence that are constructed to allow RFFS vehicles to safely pass through with minimal delay;
- h) exit/access points will need to be clearly identified. Retro-reflective tape or markers will be of assistance where the aerodrome may need to be accessible during the hours of darkness or conditions of low visibility;
- i) the mitigation of impediments to RFF vehicle mobility; and
- j) provide sufficient vertical clearance from overhead obstructions for the largest RFFS vehicle/s.

**Maintaining the Response Capability in Low Visibility Conditions**

To meet the operational objective as nearly as possible in less than optimum conditions of visibility, especially during low visibility operations, suitable guidance, equipment and/or procedures for RFF services should be provided.

RFFS vehicles should approach any aircraft accident or incident by the quickest route commensurate with safety, although this might not necessarily be the shortest distance to the incident site. Traversing through unimproved areas can take longer than travelling a greater distance on paved surfaces, therefore a

thorough knowledge by RFFS personnel of the topography of the aerodrome and its immediate vicinity for all weather conditions is paramount. The use of grid maps and careful selection of routes is essential for success in meeting the response objectives.

RFFS vehicles should be equipped with an airfield chart clearly showing all taxiways, runways, holding points and vehicle routes marked with their appropriate designation. The chart(s) should be accompanied by written instructions clearly detailing the action that the driver should take in the event of vehicle break down or that the driver should become unsure of the vehicle's position on the aerodrome.

Consideration should be given to the provision and use of technical equipment, e.g. surface movement radar, infrared vision systems, taxiway centreline lighting, vehicle positioning equipment and other navigation aids that could enhance RFFS response to the location of an accident or incident site in low visibility conditions.

Once low visibility operations have been initiated it may be necessary to restrict the operation of vehicles in the aircraft manoeuvring area. Procedures developed for ATC to assist the RFFS in case of an accident or incident should be put in place.

RFFS and associated external emergency response personnel should be made aware of the existence of any areas that may, from time to time, become impassable because of weather or other conditions, and of the location of obstacles both permanent and temporary.

Operational procedures should be developed through which Air Traffic Control (ATC) stop or divert all aircraft and non-essential traffic that conflicts with responding RFFS vehicles. RFFS personnel should continuously monitor the minimum visibility operating conditions in order to maintain response capability under such conditions.

### **13.4 TRAINING OF PERSONNEL**

The training to be undertaken by personnel appointed to specialized rescue vehicles and their associated equipment will not present significant problems. Where there are particular forms of hazard, such as the sea, mountains or desert areas, there will be individuals who have experience in operating and surviving in these environments. These experts could provide the basic instruction required by crew members, adapting as necessary to accommodate new types of equipment. The manufacturers of specialized equipment can also provide expertise. The principal aim of training will be to instill confidence in equipment of all types, to establish the operating limits of vehicles and equipment and to develop the teamwork which converts individuals into an effective crew. In this process it is essential to create team leaders who will have the absolute authority to determine when to mount a rescue operation. There may well be occasions when prudence will decree that operations in intolerable conditions would merely add to the casualties without any reasonable expectation of success.

### **13.5 INTER-AGENCY EXERCISES**

13.5.1 While the airport or appropriate authority may initiate the call for a rescue operation and dispatch a unit from within the airport there will be supporting forces from off-airport agencies. These may include, in appropriate circumstances, military units, medical services, mountain rescue teams, divers and civil defence contingents of various types. The co-ordination of these services will require the same degree of effort as is necessary in developing the airport emergency plan (see *Airport Services Manual* (Doc 9137), Part 7. — *Airport Emergency Planning*).

13.5.2 In particular, the need for effective communications will be paramount. Survivors of an aircraft accident, recovered from a difficult location, must be brought to one or more assembly points at which conventional ambulances and medical assistance will be waiting. Prior notification of injuries by radio can ensure that appropriate treatment is available and that specialized hospitals prepare reception facilities. Realistic simulations of incidents will contribute to inter-service liaison and identify areas in which improvements in facilities or procedures can provide a more effective service.

## Chapter 14

### TRAINING

#### 14.1 GENERAL

14.1.1 Personnel whose duties consist solely of the provision of RFF services for aircraft operations are infrequently called upon to face a serious situation involving life-saving at a major aircraft fire. They will experience a few incidents and a larger number of standbys to cover movements of aircraft in circumstances where the possibility of an accident may reasonably be anticipated but will seldom be called upon to put their knowledge and experience to the test. It follows, therefore, that only by means of a most carefully planned and rigorously followed programme of training can there be any assurance that both personnel and equipment will be capable in dealing with a major aircraft fire should the necessity arise. The core training programme can be organized into nine faculties as follows:

- a) fire dynamics, toxicity and basic first aid;
- b) extinguishing agents and firefighting techniques;
- c) handling of vehicles, vessels and equipment;
- d) airfield layout and aircraft construction;
- e) operational tactics and manoeuvres;
- f) emergency communication;
- g) leadership performance;
- h) physical fitness; and
- i) auxiliary modules (e.g. rescue in difficult terrain, response to biological/chemical threats etc.)

14.1.2 The core training curriculum should include initial and recurrent instruction. The scope of instruction should vary with the degree of intelligence of the trainees. In most cases the simpler this form of instruction is kept, the more successful it is likely to be. In no case should enthusiasm engendered by the interest value of the subject be allowed to carry the instruction beyond its practical application. Nevertheless, the officer responsible for the training programme must endeavour to maintain the interest and enthusiasm of the crew at all times. In certain respects this will not be too difficult. There are many factors affecting RFF procedures at an aircraft accident which may be anticipated, staged, and practised so that the officer has an opportunity of sustaining the interest indefinitely. Each new type of aircraft brings with it new problems which must be assessed and incorporated in the training programme. As certain routine aspects of training may become less interesting over a long period it is therefore essential that the officer ensure each crew member realizes the need for such training. For example, it is a fundamental practice in the RFF service that each crew member, when on duty, be satisfied that the equipment which may be used is serviceable. This particular aspect of a crew member's duty could deteriorate after a long period of comparative inaction unless that person is really convinced of the importance of this task.

14.1.3 The entire training programme must be designed to ensure that both personnel and equipment

are at all times fully efficient. This represents a very high standard of achievement but anything less than full efficiency is unacceptable and may be dangerous both to those in need of aid and also to those who are seeking to give such aid. In addition, the training programme must also be designed to build cohesiveness between key functional units of a RFF team in order to deliver a consistent level of proficiency during emergencies. To ensure a high standard of operational readiness, RFF services should develop a competency audit framework to assess the effectiveness of RFF training at both individual and team levels.

## **14.2 FIRE DYNAMICS, TOXICITY AND FIRST AID**

14.2.1 All RFF personnel should have a general knowledge of the cause of fire, the factors contributing to the spread of fire and the principles of fire extinction. Only when armed with this knowledge can they be expected to react effectively when confronted with a serious fire situation. It must be known, for instance, that certain types of fire require a cooling agent while others need a blanketing or smothering action. RFF training should also touch on the toxicity of thermal decomposition products. This will enable fire fighters to better understand the importance and limitations of their protective equipment. In doing so, fire fighters will avoid a false sense of security and take extra precautions when leading the occupants of the aircraft through a dangerous atmosphere. In addition, every member of the rescue team should, if at all possible, be trained and periodically recertified in basic medical first aid, as a minimum. The prime reason for this qualification is to ensure that casualties are well handled so as to avoid the infliction of additional suffering and/or injury in the removal of the occupants from a crashed aircraft.

## **14.3 EXTINGUISHING AGENTS AND FIREFIGHTING TECHNIQUES**

14.3.1 It is essential that a thorough knowledge should be acquired of the agents employed. In particular, every opportunity should be taken to practice the application of agents on fires in order to understand by experience not only the virtues but also the limitations of each agent. Each occasion of a routine equipment test should be used for a training exercise in the proper handling of equipment and the correct application of the particular agent involved. The combination of routine test procedures with training periods will minimize the costs involved in the discharge of extinguishing agents.

14.3.2 To carry out fire suppression at different phases of combustion, RFF personnel should be well versed in three types of extinguishment. 1) Direct straight stream firefighting method using a straight stream or solid hose stream to deliver water directly onto the base of the fire. 2) Indirect firefighting method; used in situations where the temperature is increasing and it appears that the cabin or fire area is ready to flash over. Attack is made from a small fuselage openings such as slightly opened exits or openings made in cabin windows. Indirect method is based on the conversion of water spray into steam as it contacts the super-heated atmosphere. Firefighters direct the stream in short bursts of water at the ceiling to cool super-heated gases in the upper levels of the cabin or compartment. This method can prevent or delay flashover and allow the firefighters time to apply a direct stream to the base or seat of the fire. 3) 3-dimensional method is deployed in the event that the fire is fuel fed, as in the case of an engine fire. Firefighter one directs semi-fog at the fire while firefighter two discharges dry chemical or clean agent into the semi-fog stream starting at ground level and moving upward to the source of the fire. In cases of deep seated aircraft fires, penetrating nozzles could be used. Penetrating nozzles could be in the form of vehicle turrets (monitors) or handlines capable of injecting extinguishing agents that provide wide angle coverage.



## **14.4 HANDLING OF VEHICLES, VESSELS AND EQUIPMENT**

14.4.1 All RFF personnel must be capable of handling their vehicles, vessels, and equipment, not only under drill-ground conditions, but also in rapidly changing circumstances. The aim must always be to ensure that every individual is so well versed in the handling of all types of vehicles, vessels, and equipment that, under emergency conditions, operation of these mission-critical resources will be automatic, leaving capacity to deal with unexpected scenarios. This can be accomplished in the initial stage of training by employing the snap “change-round” technique during standard drills, and later by training involving the use of two or more fire vehicles simultaneously. Particular attention should be paid to pump operations, high-reach extendable turrets, and other specialized rescue equipment. RFF crew should also be adequately trained in handling complex instrumental panels onboard vehicles and vessels. This form of training is, of course, a continuing commitment.

14.4.2 Possessing in-depth knowledge of all vehicles, vessels, and equipment is essential in order to ensure thorough maintenance which is essential to guarantee operational efficiency under all circumstances. It is important that every fire fighter be satisfied that any piece of equipment which may be used will work satisfactorily and, in the case of ancillary equipment, it is in its correct stowage position. The importance of correct stowage of small equipment to ensure that it can be instantly located cannot be over-stressed. Officers responsible for training are advised to hold periodic locker drills where individual crew members are required to produce a particular item immediately. All vehicles, vessels, and equipment must be regularly tested or inspected and records must be maintained of the circumstances and results of each test.

## **14.5 AIRFIELD LAYOUT AND AIRCRAFT CONSTRUCTION**

14.5.1 A thorough knowledge of the airport and its immediate vicinity is essential. To counter the effects of complacency, it is recommended that vehicle operators practice mental mapping techniques to supplement routine on-site familiarization. The training programme should encompass those areas of operations dealing with:

- a) thorough familiarization of the movement area so vehicle drivers can demonstrate their ability to:
  - 1) select alternative routes to any point on the movement area when normal routes are blocked;
  - 2) know the existence of ground which may become from time to time impassable in any part of the area to be covered by the service;
  - 3) recognize landmarks which may be indistinctly seen;
  - 4) operate vehicles over all types of terrain during all kinds of weather. The training programme may be conducted using vehicles other than the RFF vehicles provided they are radio controlled and have similar operating characteristics;
  - 5) select the best routes to any point on the airport; and
  - 6) use detailed grid maps as an aid in responding to an aircraft accident or incident; and

- b) the use of guidance equipment when it is available. Normally air traffic control may be assistance in providing information on the location of the accident site and position of other aircraft or vehicles on the airport which may obstruct or impair vehicle movement.

14.5.2 The importance of this aspect of training cannot be over-emphasized. RFF personnel may be called upon to effect a rescue from an aircraft cabin in conditions of great stress working in an atmosphere heavily laden with smoke and fumes. If self-contained breathing apparatus is supplied, careful training in its use is essential. It is essential that every person have an intimate knowledge of all types of aircraft normally using the airport. Appendix 1 provides an electronic link to the websites of the various aircraft manufacturers. The websites contain diagrams that provide, *inter alia*, general information on principles of rescue and firefighting procedures as well as detailed information of concern to rescue and firefighting personnel on representative aircraft commonly used in the market. The knowledge cannot be acquired solely on a study of the diagrams. There is no substitute for a periodic inspection of the aircraft. Due to the complexity of modern aircraft and the variety of types in service, it is virtually impossible to train RFF personnel on all the important design features of each aircraft although they should become familiar with the types normally used at the airport. Priority training should be given to the largest passenger aircraft as it is likely to carry the highest number of occupants and incorporate unique features such as upper deck seating capacity. Information about the following design features is of special importance to RFF personnel to ensure effective use of their equipment:

- a) location and operation of normal and emergency exits;
- b) seating configuration;
- c) type of fuel and location(s) of fuel tank(s);
- d) location of batteries and isolation switches; and
- e) position of break-in points on the aircraft.

14.5.3 As far as is practicable, RFF personnel should be allowed to operate the emergency exits and should certainly be fully conversant with the method of opening all the main doors. Generally speaking, the majority of the doors open forward. Some containing stairs will swing downwards and, on some wide-bodied aircraft, the doors retract into the ceiling area. Most large aircraft are fitted with inflatable emergency evacuation slides affixed to cabin doors and large emergency exit windows. If the emergency evacuation slides are not automatically disengaged, or if the system equipment malfunctions, the slides may become inflated when the exit is opened. The doors of large aircraft are normally operated from the inside. There are occasions, however, when responding RFF personnel may have to open doors from the outside of the aircraft to gain access to the cabin interior. In view of the variables noted above, the opening of the normal and emergency exits may be hazardous for the airport fire fighter if the appropriate cautionary measures are not taken. For example, it is hazardous to open armed aircraft doors if the fire fighter is standing on a ladder or to rest the ladder against the door to be opened.

14.5.4 Aircraft operators and flight crew members should be requested to co-operate to the fullest extent in arranging inspection by RFF personnel the different types of aircraft using the airport. An elementary knowledge of aircraft construction is highly desirable since such knowledge is invaluable if, as a last resort, forcible entry is necessary. The co-operation of the appropriate staff of the airline operators should be sought on this aspect of training.

14.5.5 All aircraft carry small portable fire extinguishers that could be of use to rescuers. Extinguishers containing carbon dioxide, a halon agent or water are usually located on the flight deck, in galleys and at other points within the cabin. All extinguisher positions are indicated and the extinguisher body normally carries a label stating the type of fire for which its contents are suitable. Water and other beverages found in the buffet compartment provide an additional source of water for extinguishment purposes. It should be emphasized that these extinguishing agents are of secondary value and should not be relied on.

## 14.6 OPERATIONAL TACTICS AND MANOEUVRES

14.6.1 When personnel are well versed in the handling of firefighting equipment they should receive training in operational tactics to be adopted at aircraft fires. This training is a continuing commitment and must be absorbed to the point where compliance with the initial action called for is instinctive, in the same sense that hose-running to a well-trained regular fire fighter is automatic and will therefore, follow even when working under stress. Only when this is achieved will the officer-in-charge be in a position to assume complete control of the situation. Operational tactics training is designed to deploy personnel and equipment to advantage in order to establish conditions in which aircraft occupants may be rescued from an aircraft which is involved in, or liable to become involved in, fire. The objective is to isolate the fuselage from the fire, cool the fuselage, establish and maintain an escape route and achieve the degree of fire control necessary to permit rescue operations to proceed. This is fundamental and must be stressed in the training programme. The service to be provided is primarily a life saving organization, one, however, that must be trained in firefighting because aircraft involved in a serious accident are frequently involved in fire. The firefighting operations must be directed to those measures which are necessary to permit rescue to be carried out until all the occupants of the aircraft are accounted for. This includes precautionary measures at those incidents where no fire has broken out. When the life saving commitment has been met it is necessary, of course, to utilize all available resources to secure protection of property.

14.6.2 The main attack on the fire should usually be by means of mass application of foam in an endeavour to achieve maximum cooling and the rapid suppression of the fire. Since, however, foam, like every other agent, has limitations, a suitable back-up agent must be available to deal with those pockets of fire which are inaccessible to direct foam application. This will generally be provided in the form of dry chemical powder. The use of these should be confined to running liquid fuel fires, fires in enclosed spaces such as wing voids, or for dealing with a special fire such as a fire in an engine nacelle or undercarriage well.

14.6.3 Points which should be covered in the operational tactics training programme are described below.

14.6.4 *The approach.* Equipment should approach the accident site by way of the fastest route in order to reach the site in the shortest possible time. This is quite frequently not the shortest route because generally speaking it is preferable where possible to travel on a made-up surface than to approach over rough ground or grassland. The essence is to ensure that RFF vehicles get there and are not subjected to unnecessary hazards en route. When nearing the scene of the accident a careful watch must be maintained for occupants who may be dashing away from the aircraft or who may have been flung clear and are lying injured in the approaches. This applies particularly at night and calls for competent use of spot or search lights.

14.6.5 *Positioning of equipment.* The positioning of equipment both from the airport and from any supporting local fire department is important in many respects and regard should be given to several

factors. Correct positioning of equipment must permit the equipment operator an over-all view of the fire area. The equipment must not be placed in a position of hazard due to fuel spills or ground slope or wind direction. It must not be positioned too close to the fire or to other equipment and thus restrict working space (this applies particularly to foam tenders and their attendant auxiliary water tenders). Other factors which should be taken into account are the location of aircraft occupants relative to the fire, impact of wind, fire, personnel and fuel tanks and location of emergency exits.

14.6.6 In certain circumstances it may be advantageous to leave the equipment on hard standing, though this may mean an additional length of fire hose. More time can be lost attempting to reach a closer position to the fire by negotiating rough ground than would be taken to run an additional length of fire hose. Moreover, if parked on hard standing the equipment is capable of being moved rapidly if conditions demand. Aircraft accidents frequently occur in circumstances where equipment cannot be positioned in the immediate vicinity. Consequently it is recommended that all firefighting and rescue equipment should be designed so that it can be brought to bear at some distance from the parent equipment. Operational tactics training can do much to reduce the problems of positioning equipment, can be conducted at very little cost and should be performed frequently to develop acceptable practices. For this particular phase of operational tactics training it is not always necessary to produce water or foam; it is an example of how “dry drills” can help to raise efficiency standards.

14.6.7 In order to achieve the main initial objective of isolating and cooling the fuselage and to safeguard the escape route it is evident that the positioning of foam streams is of the utmost importance. The number of streams available will vary with the type and the scope of the equipment provided.

14.6.8 Foam streams should be positioned as close as possible to the fuselage, the initial discharge being directed along the line of the fuselage and then directed to drive the fire outwards. When selecting the ideal position for the stream it should always be remembered that the wind has considerable influence upon the rate of fire and heat travel. The position should be chosen with this in mind, thus utilizing the wind, wherever possible, to assist in the main objective. Except in exceptional circumstances, foam streams should not be directed long the line of the wind towards the fuselage as this may tend to flush free fuel into the danger area. Similarly, care must be exercised to avoid the possibility of one stream disturbing the foam blanket laid down by another stream.

14.6.9 There are two basic methods of applying foam. One is to use a long straight stream to allow fall on the desired area. The other is to apply a diffused stream at close range. Often foam can be applied to a fire area by deflecting it from another surface such as the contour of the fuselage or main plane. Whenever foam, dry chemical powder, or other complimentary agent equipment is being subjected to a periodic routine check the opportunity should be taken to train emergency crew members in the methods of application. It is important that this be carried out on a fire so that each person will obtain an assessment of the value as well as the limitations, of each agent so applied, and be familiar with the heat conditions that will be experienced. These drills should be carried out at intervals of not more than one month. Increasingly, firefighting equipment is designed to provide high output through monitor/turrets to deal with accidents involving the largest aircraft currently in service. Monitor/turret operators must be highly skilled in the application of foam to be able to avoid wastage, through misdirection of aim, to know when to change from straight stream to diffused stream, and to readily appreciate how to avoid damage or injury to others by the potential force of the foam stream.

14.6.10 It is vital that the RFF fleet manoeuvres in a coordinated formation and concentrate foam streams at areas where large numbers of passengers may be trapped. With precision manoeuvres, continuous mass application of foam will be met with least wastage. For this reason, officers responsible for training should decide which particular pattern of equipment positioning is best suited to their available resources and then take steps to train crew members in its positioning and layout. At a fire there

is little time for individual briefing of crew members and the initial layout may well be adjusted to cope with the existing circumstances, but it is necessary for the crew members to know exactly what their first action should be well in advance through a predetermined tactical plan as dictated by the circumstances. It should always be remembered that this layout of equipment should be standard practice at an aircraft accident even when fire has not broken out and that at least one monitor/turret should be staffed and in readiness to go into instant action should the occasion arise.

14.6.11 The main objective of the firefighting activity must be to extinguish the fire and secure it against reignition in the shortest possible time. It is also pertinent that RFF crew maintain a good sense of situational awareness at all times during an emergency. This demands skill, teamwork and understanding by all those involved. The first responding fire vehicle may carry agents which can achieve some rapid knockdown of an area of the fire, but this will in most cases require the early support of any other vehicle to continue the effort and secure the entire area against reignition and to promote the necessary cooling effect in the vicinity of the passenger compartment. The entire effort must be concentrated on this area since the misapplication of foam or other agents is wasteful and could mean the difference between the success or failure of the operation. Where foam production through a monitor/turret is undertaken with the vehicle in motion (i.e. pump and roll mode), considerable skill is required to achieve maximum effect.

14.6.12 Great care must be exercised by monitor operators in the application of foam in straight streams in the vicinity of escape slides deployed from the aircraft. RFF personnel must also anticipate that evacuating occupants may become distressed and disoriented by the presence of dry chemical powder clouds or by the impact of foam streams and should therefore conduct their operations so as to minimize these effects.

14.6.13 The training programme should provide instruction in search procedures, not only in enclosed spaces of an aircraft, but also for procedures for systematic searching of the area in the immediate vicinity of an aircraft accident and also in the path of the aircraft. As a broad principle, it should be taught that the persons involved in a fire are most frequently found near an exit, i.e. doors and windows, or will have sought shelter, however inadequate in lavatories and lockers, etc. Rescue is always best effected by way of a normal channel, if available. For example, it is easier to carry a person through a doorway than to manipulate that person through a window. The main cabin door of an aircraft should always be attempted first. Should the door be jammed, it will usually be found quicker to force it by applying leverage at the right spot than to achieve entry and rescue through another form of opening. Success in this form of operation requires a full knowledge of the locking mechanism and direction of travel of the door concerned. Only when everything else has failed should forcible entry be attempted. External markings are now provided on many aircraft showing suitable points at which entry can be made.

14.6.14 Pressurized cabins will offer tough resistance to penetration by forcible entry tools, although entry can be made by a person well trained in the use of such tools and possessing a working knowledge of aircraft construction. The practice of providing power-operated saws and other similar forms of forcible entry tools on all airports normally handling this type of traffic has increased. All operational staff should be trained in rescue procedures. The working space inside a cabin is somewhat restricted and it will generally be found advisable to limit the number of rescuers working inside the aircraft and to work on a chain principle. Where possible, the airport emergency plan should provide for the availability to staff other than RFF personnel, for the handling of casualties from the moment they are removed from the aircraft. All rescue staff should be trained in lifting and carrying casualties, and other forms of rescue.

## **14.7 EMERGENCY COMMUNICATION**

14.7.1 Emergency communication refers to the information flow between various responding agencies during an emergency. Accurate and relevant information provides the RFF crew with shared real-time knowledge. This in turn empowers RFF teams to plan or initiate rescue efforts in an integrated manner. To ensure swift and accurate transmission of information, it is stressed that RFF staff be adequately trained in operating the primary and secondary communication systems installed at the fire stations and fire vehicles / vessels. Equally important, RFF personnel should learn to converse succinctly using appropriate telephony language. RFF personnel should also be trained to communicate with the flight crew through internationally accepted ground-to-aircraft hand signals.

## **14.8 LEADERSHIP PERFORMANCE**

14.8.1 The leadership qualities exhibited by an RFF team commander often determines the outcome in an emergency response. The commander leads and motivates his staff in achieving peak performance under challenging operating environment. In this regard, a robust leadership training program should be instituted to better prepare RFF leaders in assuming command during crises.

## **14.9 PHYSICAL FITNESS**

14.9.1 During protracted rescue operations, the ability of RFF personnel to perform strenuous activities over an extended period of time influences the overall operational effectiveness. Therefore fire fighters must be aerobically and anaerobically fit to withstand the rigours of a variety of operations. Clearly, physical fitness training requirements should be designed to commensurate with the equivalent fitness intensity generated in the performance of RFF operations which include the use of breathing apparatus, hand lines, ladders, heavy equipment and other associated rescue operations such as casualty handling.

## **14.10 AUXILIARY MODULES**

14.10.1 Depending on the aerodrome operating environment, it may be necessary for RFF crew to be trained in dealing with difficult environments such as water rescue and handling biological / chemical threats. While RFF services should continue to strengthen their core capabilities, it is worthwhile to explore and train beyond the immediate operational responsibilities to deal with unexpected contingencies at or in the vicinity of the airport.

## Chapter 15

### AIRCRAFT FUELLING<sup>1</sup> PRACTICES

#### 15.1 INTRODUCTION

15.1.1 The airport authority, the aircraft operator and the fuel supplier each has responsibilities in respect of the safety measures to be taken during fuelling operations. Some guidance on these safety measures is given below. It is important to note that this material is not intended to replace fuel supplier operator procedures which are usually developed to meet requirements imposed by special equipment, national regulations, etc. The material includes the following subjects:

- a) general precautionary measures to be taken during fuelling operations; and
- b) additional precautionary measures to be taken when passengers remain on board or embark/disembark during refuelling operations.

*Note.- Further information on internationally accepted petroleum and aviation industry fuel practices, including fuel quality control and operations, can be found in Doc 9977, Manual on Civil Aviation Jet Fuel Supply.*

#### 15.2 GENERAL PRECAUTIONARY MEASURES TO BE TAKEN DURING AIRCRAFT

##### FUELLING OPERATIONS

The following general precautionary measures should be taken during aircraft fuelling operations:

- a) aircraft fuelling operations should be done outdoors; and
- b) bonding and/or grounding, as appropriate, should be done in accordance with 16.4;
- c) aircraft fuelling vehicles should be positioned so that:
  - 1) accessibility to aircraft by RFF vehicles is not interrupted;
  - 2) a cleared path is maintained to permit rapid removal of fuelling vehicles from an aircraft in an emergency;
  - 3) they do not obstruct evacuation from occupied portions of the aircraft in the event of a fire; and
  - 4) the vehicle engines are not under the wing;
- d) all vehicles performing aircraft servicing functions other than fuel servicing (e.g. baggage trucks, etc.) should not be driven or be parked under aircraft wings while fuelling is in progress;

<sup>1</sup> Throughout this chapter the term fuelling requirements encompasses refueling and defueling.

- e) open flames and lighted open flame devices should be prohibited on the apron and in other locations within 15 m of any aircraft fuelling operation. Included in the category of open flames and lighted open flame devices are the following:
  - 1) lighted cigarettes, cigars, pipes;
  - 2) exposed flame heaters;
  - 3) welding or cutting torches, etc.; and
  - 4) flare pots or other open flame lights;
- f) cigarette lighters or matches should not be carried or used by anyone while engaged in aircraft fuelling operations;
- g) extreme caution should be used when fuelling during lightning and electrical storms. The fuelling operations should be suspended during severe lightning disturbances in the immediate vicinity of the airport;
- h) when any part of an aircraft undercarriage is abnormally heated, the airport RFF service should be called and fuelling should not take place until the heat has dissipated; and
- i) portable fire extinguishing equipment suitable for at least initial intervention in the event of a fuel fire and personnel trained in its use shall be readily available and there shall be a means of quickly summoning the rescue and fire-fighting service in the event of a fire or major fuel spill. It should be ensured by regular inspection and maintenance that this equipment is maintained in a fully serviceable condition.

### **15.3 ADDITIONAL PRECAUTIONARY MEASURES TO BE TAKEN WHEN PASSENGERS REMAIN ON BOARD OR EMBARK/DISEMBARK DURING REFUELLING OPERATIONS**

15.3.1 Because of the importance of reducing transit times and for security reasons, some States allow passengers to remain on board during refuelling operations while others allow passengers to embark and disembark. However, an aircraft shall not be refuelled when passengers are embarking, on board or disembarking unless it is properly staffed by qualified personnel ready to initiate and direct an evacuation of the aeroplane by the most practical and expeditious means available.

15.3.2 When aircraft refueling operations take place while passengers are embarking, on board or disembarking, ground equipment shall be positioned so as to allow:

- a) the use of a sufficient number of exits for expeditious evacuation; and
- b) a ready escape route from each of the exits to be used in an emergency.

15.3.2 The following additional precautions must be observed during refuelling operations while passengers remain on board or embark/disembark.

- a) passengers should be warned that refuelling will take place and that they must not smoke, operate switches or otherwise produce sources of ignition;
- b) the illuminated “No smoking” signs and exit lighting should be switched on;
- c) aircraft equipped with integral stairs should have them deployed, or if aircraft stairways are used, these



should be positioned at each of the main doors normally used for passenger embarkation or disembarkation which should be open or ajar and free from obstruction.

- d) if, during refuelling, the presence of fuel vapour is detected in the aircraft interior, or any other hazard arises, refuelling and all cleaning activities using electrical equipment within the aircraft should be stopped until conditions permit resumption; and
- e) where passengers are embarking or disembarking during refuelling their route should avoid areas where fuel vapours are likely to be present and this movement should be under the supervision of a responsible person.

## Chapter 16

### AVAILABILITY OF RFF INFORMATION

#### 16.1 GENERAL

16.1.1 In accordance with Annex 14 Volume 1, 2.11 there is a need for the airport or appropriate authorities responsible for RFF services to make available to the appropriate air traffic services units and aeronautical information services units information concerning the level of protection normally provided at the airport for aircraft RFF purposes. Changes in the level of protection should also be reported.

16.1.2 The level of protection normally available at an airport should be expressed in terms of the category of the RFF services as described in Table 2-3 of this manual, in accordance with the types and amounts of extinguishing agents normally available at the airport.

16.1.3 Changes in the level of protection normally available at the airport for RFF (RFF category) should be notified to the appropriate air traffic services units and aeronautical information units to enable those units to provide the necessary information to aircraft using that particular airport. When such a change has been identified the above units should be advised accordingly and as soon as practical to do so. A change in RFF category may be the result of, *inter alia*, unavailability of extinguishing agents, unavailability of equipment to deliver the agents or unavailability of enough personnel to operate the equipment.

16.1.4 Notification of changes to RFF category should be initiated even for short durations if it is known or likely to affect aircraft movements at the aerodrome.

16.1.5 Notification to industry should also include the hours of operations for a RFF service as well as any special services or resources, such as the availability of a water rescue service, a dedicated emergency radio frequency or similar.

## Chapter 17

### PREVENTIVE MAINTENANCE OF VEHICLES AND RESCUE EQUIPMENT

#### 17.1 General

- 17.2.1 The principle objective of an airport RFF service (RFFS) is to “save lives in the event of an aircraft accident or incident”. The most important aspects bearing on effective rescue in a survivable aircraft accident or incident is the training received and the effectiveness of the fire vehicles and associated rescue equipment and the speed in which personnel and equipment can be deployed.
- 17.2.2 Annex 14, Volume I requires that a maintenance programme, including preventive maintenance where appropriate, shall be established to maintain facilities in a condition which does not impair the safety, regularity or efficiency of air navigation.
- 17.2.3 Due to the ever increasing complexity of specialized aviation fire vehicles and their associated rescue equipment a program of regular and on-going preventive maintenance is paramount to ensure availability and reliability. A robust maintenance program would also maximize the lifecycle of both fire vehicles and rescue equipment.

#### 17.2 Preventive Maintenance

- 17.2.1 To ensure on-going reliability and peak performance of any fire vehicle or item of rescue equipment is maintained, and to ensure that Rescue Firefighting (RFF) services are provided at the required levels, all RFF vehicles and rescue equipment need to have regular preventive maintenance conducted on them.
- 17.2.2 To ensure that the maintenance can be conducted correctly, provision of the following is a necessity:
- a) maintenance personnel;
  - b) maintenance procedures;
  - c) defect reporting system;
  - d) designated maintenance work areas;
  - e) tools;
  - f) spare parts; and
  - g) storage of maintenance records.
- 17.2.3 A maintenance programme should take into account the following activities:
- a) original equipment manufacturer (OEM) maintenance recommendations;
  - b) local environmental conditions, for example tropical heat versus cold winters;
  - c) national or local regulatory requirements – for example certification of pressure vessels, hoses, road worthiness certificates; and
  - d) regular performance testing.

### **17.3 Personnel**

- 17.3.3 All personnel conducting maintenance activities should be appropriately skilled, trained and equipped to undertake the designated and required maintenance activities they are tasked with in accordance with their organisational Safety Management Systems.
- 17.3.2 Working on modern day RFF fire vehicles and rescue equipment requires the following skill set or, as a minimum, a good practical working knowledge of:
- a) heavy vehicle mechanical trade qualifications;
  - b) fire pumps and foam systems;
  - c) complementary agent systems;
  - d) hydraulics / pneumatics;
  - e) automotive electrical training;
  - f) Self-Contained Breathing Apparatus (SCBA) systems / breathing air compressors;
  - g) knowledge of regulatory requirements pertaining to provision of RFF; and
  - h) knowledge of national or local regulations pertaining to maintenance activities.
- 17.3.3 Specialist training should be initially provided by the OEM with the delivery of the first of type fire vehicle or item/s of rescue equipment.
- 17.3.4 National or local regulatory requirements may require personnel working on this type of equipment to be licenced.

### **17.4 Maintenance Procedures**

- 17.4.1 Maintenance procedures should be implemented to ensure a standardized manner in which fire vehicles are maintained. Maintenance procedures should cover:
- a) activities to be undertaken to ensure that disruption to RFF services are minimized. For example; bringing reserve fire vehicles into operational service to maintain category levels, or conducting maintenance during breaks in aircraft movements where a vehicle may be taken out of service without affecting category levels;
  - b) the frequency of maintenance services;
  - c) activities to be undertaken at each type of maintenance service as recommended by the original equipment manufacturer (OEM). For example, visual check, inspections & measurements;
  - d) activities to be undertaken at each type of maintenance service as recommended by national or local regulations;
  - e) arrangements for technical support from the OEM or the OEM's local agent;
  - f) spare parts that should be held on site to enable regular maintenance to be conducted for example; filters, belts, drier cartridges, lubricants, coolants, wiper blades;
  - g) generically common spare parts should be held on site to minimise downtime. Such as switches, light globes, relays, circuit breakers, bolts, nuts, washers, O-rings and seals;
  - h) arrangements with OEM and local suppliers for all other parts to ensure downtime is kept to a minimum;
  - i) tyre replacement requirements;
  - j) environmental procedures including appropriate disposal procedures for old parts as well as used lubricants and coolants;

- k) any special measures to ensure safety of maintenance personnel such as procedures for working at heights, confined space entry and working with high pressure liquids / gasses; and
- l) the method of reporting and documenting any defects that have been identified with the fire vehicles or rescue equipment by operational and maintenance personnel.

### **17.5: Maintenance Work Areas / Special Tools**

17.5.1 Provision of a work area for maintaining RFF fire vehicles should have due consideration to the following:

- a) a sufficiently large enough area to work on and around the vehicle;
- b) environmental protection such as trade waste interceptor pits or bunding;
- c) lifting / jacking equipment;
- d) wheel lifters / tyre changing cages;
- e) storage areas for lubricants, spare parts and tools;
- f) storage of technical documentation; and
- g) storage of maintenance records.

17.5.2 Provision of a work area for maintaining rescue equipment should have due consideration to the following:

- a) a clean area to work on breathing apparatus (BA) sets / face masks;
- b) testing capability for fire hoses;
- c) ventilated area for operation of engine powered tools, for example, portable saws or hydraulic rescue units; and
- d) ventilation for charging batteries.

17.5.3 Modern day RFF fire vehicles / rescue equipment have the need for specialist diagnostic and test equipment. It should be noted that some tools require regular calibration to ensure that they are measuring correctly. Some examples are:

- a) multimeters;
- b) liquid flow meters;
- c) tension wrenches;
- d) pressure gauges; and
- e) air quality testing for BA.

17.5.4 To comply with national or local regulations, some workshop equipment used by maintenance personnel may require regular safety certification by an accredited certifying body. Some examples are:

- a) lifting / jacking equipment such as cranes, pulleys, slings, chains, shackles
- b) workshop air receivers;
- c) pressure test equipment, such as hoses and fittings; and
- d) electrical test and tagging of Alternating Current (AC) equipment, such as power tools, electrical cables, and workshop machines.

### **17.6 Performance Testing – Fire Vehicles**

17.6.1 Whilst a RFFS fire vehicle may pass its initial acceptance test for compliance against its specification, there is no guarantee that it will continue to do so throughout its service life. All RFFS fire vehicles have parts that wear with time and as a result performance is lost. To ensure that the fire vehicle continues to have the ability to respond, and discharge firefighting agents at the required amounts, regular performance testing should be undertaken including quantitative checks of:

- a) 0-80 km/h acceleration;
- b) braking;
- c) flow rate from high and low flow deliveries;
- d) foam admixing percentages;
- e) monitor throw; and
- f) compressed air foam systems.

17.6.2 Records of any performance tests undertaken should be retained, as it is a record of the fire vehicle continuing to meet the specifications, and allows future review if performance starts to deteriorate. Where multiple fire vehicles of the same type are stationed at the same location or operated by the same organisation, it allows prediction of when the same performance deterioration may occur on other fire vehicles.

## **17.7 Rescue Equipment Requirements**

17.7.1 The maintenance requirements for rescue equipment should be in accordance to original equipment manufacturer (OEM) requirements. However, due to the nature of firefighting equipment can sometimes unknowingly become damaged. Consequently it can also be beneficial to check the following:

- a) all items – regular daily or weekly checks to ensure functionality;
- b) BA sets – maintained after every use and checked regularly when not used for safe operation;
- c) BA air quality – regularly checked (there may be national or local standards that the air quality must meet);
- d) short lines / long lines (rescue lines) – not frayed and are in good repair;
- e) portable fire extinguishers – full and charged with pressure;
- f) fire hoses – inspected and pressure checked on an annual or 6 monthly basis to ensure that the hoses don't leak and the couplings are functioning and securely fitted;
- g) nozzles / foam branches – inspected for damage;
- h) rescue tools – inspected to ensure that there is no damage to components. Under high forcing loads, damaged components can be very dangerous if they fail;
- i) general tools – inspected to ensure handles are not broken or damaged;
- j) first aid kits – inspected at least weekly to ensure that items are maintained at the correct stock levels; and
- k) rescue tool box – checked to ensure all tools are present

## **17.8 Maintenance Documentation**

17.8.1A complete set of maintenance documentation should be requested to be delivered with the fire vehicle and rescue equipment during the procurement process. As a minimum this should include:

- a) operating procedures;
- b) maintenance procedures;
- c) fault diagnosis and troubleshooting;
- d) adjustment procedures;
- e) removal / replacement of parts and repairable assemblies;
- f) instructions for disassembly and reassembly of repairable components;
- g) tolerances, specifications and capacities;
- h) illustrations and exploded views;
- i) schematic drawings. For example; electrical wiring circuits, pneumatic circuits, chassis air circuits or hydraulic circuits;
- j) special tools needed for repairing and adjusting; and
- k) spare parts catalogue providing exploded views of the entire fire vehicle.

17.8.2 It is important that the technical documentation is in a format the can be easily read, understood and followed.

17.8.3 Any schematic drawings should be a sufficiently large enough size to enable them to be easily read. This is very important for fault diagnosis whereby any circuits can be traced. As a minimum, all drawings should be of A1 size or similar. It is a good idea to laminate these so that they can be kept clean of grease and still be read at a later time.

## **17.9 Maintenance Record Keeping**

17.9.1 A comprehensive set of maintenance records should be kept for each fire vehicle.

17.9.2 Keeping individual sets of maintenance records is also beneficial for each of the larger and more complex items of rescue equipment. Like items of rescue equipment, for example hoses, can be grouped together, however each item of equipment should be readily identifiable via a unique numbering system.

17.9.3 Keeping such documentation has several benefits:

- provides a historical record of the maintenance of the fire vehicle / equipment – which may be an organizational requirement for legal or compliance reasons;
- provides evidence for any warranty claim that may be made against the OEM;
- can be referred to in the future (if a similar fault occurs); and
- provides evidence for any surveillance audit that may be undertaken for regulatory compliance.

17.9.4 Maintenance and calibration certificates should be maintained in a register for all special tools and test equipment.

## 17.10 Protective Clothing

17.10.1 Protective Clothing normally includes, but is not limited to, Turnout Suits (Jacket – Overtrousers c/w braces), fire fighting boots, gloves and helmet as a minimum. The proper care and preventive maintenance is normally the responsibility of the fire fighter and the RFFS.

17.10.2 Protective clothing needs to be inspected for serviceability on a regular basis:

- a) by the wearer prior to commencing duty;
- b) after use; and
- c) as required.

17.10.3 There are three levels of cleaning defined in NFPA 1851 – routine, advanced and specialized:

- routine cleaning is performed after any fire ground use where soiling has occurred and may involve brushing debris from the clothing, rinsing it with water and/or applying spot cleaning as required;
- advanced cleaning is more thorough with a frequency dependent on the use and condition of the clothing;
- specialized cleaning may need to be conducted by an external agency; and
- any cleaning should consider and comply with manufacturer instructions.

*Note:- See NFPA 1851, Chapters 6 to 9 on provisions concerning inspection, cleaning and decontamination, repair and storage of protective clothing.*

17.10.4 Minor repairs may be conducted at a local level, however, major repairs may need to be conducted by an external agency so that repair activities and/or materials do not compromise the protection standards of any protective clothing.

17.10.5 Storage of protective clothing is also a factor to be considered:

- a) storage should be away from direct light, especially sunlight;
- b) avoid contact with contaminants; and
- c) avoid storing near objects that could physically damage the protective clothing.

## Chapter 18

### HUMAN FACTORS PRINCIPLES

#### 18.1 GENERAL

18.1.1 The subject of human factors is about people. It is about people in their working and living environments. It is about their relationship with equipment, procedures and the environment. Just as importantly, it is about their relationships with other people. Human Factors involve the overall performance of human beings within the aviation system; it seeks to optimize people's performance through the systematic application of the human sciences, often integrated within the framework of system engineering. Its twin objectives can be seen as safety and efficiency.

18.1.2 Human Factors is essentially a multidisciplinary field, including but not limited to; psychology; engineering; physiology; sociology; and anthropometry. Indeed, it is this multidisciplinary nature and the overlapping of the constituent disciplines that make a comprehensive definition of Human Factors difficult.

#### 18.2 THE SHELL MODEL

18.2.1 Human factors specific to ARFF services pervade a wide spectrum of activities, ranging from training and operations to station routine and audits. The study of human factors principles can be described as both an art and a science and must be associated with the entire range of RFF activities in order to achieve a higher level of professionalism, a higher state of operational effectiveness and a higher standard for safety.

18.2.2 The SHELL model provides a conceptual framework to help understand Human Factors. It illustrates the various constituents and the interfaces – or points of interaction – which comprise the subject. Human Factors elements can be divided into four basic conceptual categories:

- a) *Software*: plans, procedures, documentation etc.
- b) *Hardware*: machine, equipment, etc.
- c) *Environment*: internal (e.g. workplace), external (e.g. surroundings) etc.
- d) *Liveware*: the human factor

18.2.3 Interactions between people and the other elements of the SHELL model are at the heart of Human Factors, which involves the interfaces between:

- a) People and machines – “Liveware vs. Hardware”
- b) People and procedures – “Liveware vs. Software”
- c) People and colleagues – “Liveware vs. Liveware”
- d) People and workplace – “Liveware vs. Environment”



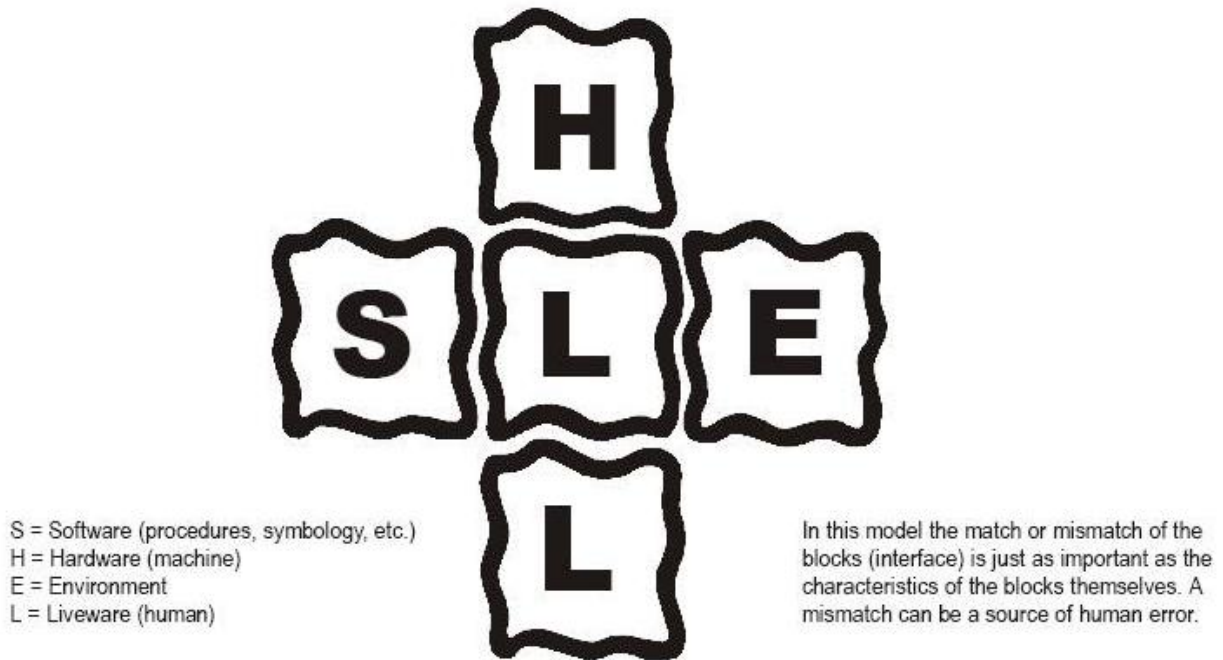

The SHEL model as modified by Hawkins

### 18.3 HUMAN FACTORS ISSUES IN RFF SERVICES

18.3.1 A competent and professional RFF service must rely on a comprehensive and relevant set of training modules, coupled with an internal audit framework to regularly check the effectiveness and efficacy of these programmes. However, in the process of promulgating the training framework, one must not be overly fixated with the 'hard' skills component of the training outcomes. Thought must be given to the 'soft' human factor components during the promulgation and execution of the training programmes. Similarly, any assessment of the operational effectiveness of RFF personnel must take into account human factor principles such as team coordination.

18.3.2 Human factors principles are not only confined to the development of RFF training programmes. Consideration must also be given to the formulation of drawer plans such as the aerodrome emergency plan and the unit tactical plans of the RFF service.

18.3.3 The application of human factor principles to RFF services can therefore be classified into two broad pillars as follow:-

- a) Operational effectiveness and standards; and
- b) Safety and well-being of RFF personnel

## **18.4 OPERATIONAL EFFECTIVENESS AND STANDARDS**

18.4.1 As the success of any RFF operations rely very much on teamwork, the importance of building mutual trust and team coordination amongst staff during training cannot be overstressed (Liveware vs. Liveware). Training must therefore be designed to guide RFF personnel towards achieving these objectives.

18.4.2 In order for RFF training to be as realistic as possible, live fire training is crucial in helping RFF personnel acclimatize to a heat and smoke filled environment (Liveware vs. Environment), so that in the event of an actual emergency, RFF personnel will be able to execute their tasks more confidently and effectively. Where possible, simulators replicating different facades of RFF operations (e.g. vehicle driving and operations; command and control etc.) should be made available for RFF personnel to be trained in a controlled, safe and realistic environment.

18.4.3 RFF operations require firefighting personnel to be proficient in the operation of fire vehicles and other rescue equipment (Liveware vs. Hardware). This is crucial as it would enable the RFF service to control any aircraft fires swiftly and effectively, in order to facilitate the evacuation and rescue of survivors. The airport fire vehicle is therefore an extremely vital asset that must be designed to take into account the human instinct and intuition of the vehicle operator. Therefore, RFF services must place sufficient emphasis on the design ergonomics of fire vehicles during the pre-fabrication stage in order to optimize human performance during training and operations.

18.4.4 The design of fire stations is another important factor that could affect the human performance of RFF personnel when responding to aircraft accidents or incidents (Liveware vs. Environment). This is especially relevant for large aerodromes which provide a high category of runway fire protection. Fire stations in such aerodromes are typically larger, thus requiring RFF personnel to travel a longer distance before reaching their fire vehicles. Such considerations must therefore be taken into account during the design phase of a fire station so that the RFF service is able to meet the stipulated response time in the event of an aircraft emergency.

18.4.5 Communication is possibly the most important human factor in RFF operations. Operational readiness and safety standards will be compromised without effective communication amongst RFF personnel, air traffic control and pilots. Therefore, the type of communications equipment and the transmission of messages must allow critical information to be conveyed, assimilated, processed and executed (Liveware vs. Hardware and Liveware vs. Liveware). Therefore, RFF training programmes must incorporate components to ensure the accurate and timely transmission of information to avoid miscommunication which could result in serious consequences.

18.4.6 It is obvious that any RFF service will need to be kept up-to-date with the constant development and innovation of more sophisticated rescue equipment and fire vehicles (Liveware vs. Hardware). It is equally important for RFF personnel to be well acquainted with the different configurations of various aircraft types operating at the particular aerodrome. Boosting the knowledge of RFF personnel in these areas would indirectly enhance human performance during a response to any aircraft emergency.

18.4.7 The RFF industry is a highly specialised one which compels the management and leadership team of RFF services to promulgate a system of self-audit. Such systems must not only include the ratings and revalidation of individual standards. More importantly, as we recognise the importance of teamwork and team coordination in RFF operations, RFF services should place heavy emphasis on the collective performance of an RFF outfit during such an audit (Liveware vs. Liveware). The audit can then reveal observations and findings about the effects of human behaviour on pre-stipulated procedures. Similarly, such audits can also highlight human reaction to any unforeseen circumstances in the form of injects

during a unit proficiency test. Results from the audits can then be used to modify, tweak and improve training programmes in order to enhance human performance during RFF operations.

## **18.5 SAFETY AND WELL-BEING OF RFF PERSONNEL**

18.5.1 In the aftermath of an aircraft accident, it is often necessary to provide psychological treatment for the survivors. However, airport operators and RFF services must also not neglect the mental and psychological well-being of emergency responders such as RFF personnel who may suffer from post traumatic stress disorders. Appropriate counseling of psychological therapy may need to be provided to RFF personnel who responded to such emergencies and who subsequently not able to cope with the stress they face thereafter. Such situations may arise from the gruesome sight of a crash scene that made them not being able to carry on with their normal lives. It will therefore be essential to also provide psychological treatment for RFF personnel after a major crisis (Liveware vs. Liveware) both from a welfare perspective and also from a business continuity stand point. Such treatment and counselling can be provided by other RFF or airport personnel who had undergone the proper training or more likely to be provided by external medical institutions. Arrangements for the latter should then be formalized in the form of mutual aid agreements or can be incorporated into the airport emergency plan (Liveware vs.. Software).

18.5.2 The job nature of RFF personnel poses numerous potential hazards (Liveware vs. Environment). The risk of inhalation of carbon or smoke particles when extinguishing a fire, either during an incident or during training, is very high. Therefore, RFF services must provide all fire fighters with the appropriate personal protective equipment (PPE) such as self-containing breathing apparatus (SCBA), helmets, boots, protective clothing etc. In relation to day-to-day operations, the uniform worn by RFF personnel should also be of a suitable material depending on the local climate and conditions.

18.5.3 To ensure that RFF personnel are able to perform their roles effectively, thought needs to be put into designing an appropriate physical fitness programme to condition them for the physical rigours of the job (Liveware vs. Environment). In the process of designing any physical fitness programmes, due considerations must be given to individual human limitations. RFF management must also accept that not all personnel can perform at the same level of physical fitness standard. The key is to establish the minimum physical fitness requirements of a fire fighter and design a programme that can best replicate these demands.

18.5.4 Noise is an important human factor (Liveware vs. Environment) that is omnipresent in an airport environment and cannot be ignored. Most fire stations are located within close proximity of the runway and aircraft movement areas, thus exposing RFF personnel to constant loud noises. Besides posing as disruptive interferences during the transmission of messages, long term and regular exposure to noise can have serious implications on one's health (e.g. temporary, partial or permanent hearing loss). To address this issue, RFF services should issue and mandate the use of suitable hearing protection devices. In addition, personnel who are subjected to constant exposure to noise should be sent for regular noise induced deafness (NID) hearing tests.

18.5.5 Fatigue is one important factor that directly affects human performance and is greatly influenced by the shift system of RFF services (Liveware vs. Software). Besides the need to conform to local labour rules and regulations of individual States, there must be considerations to ensure that RFF personnel can have sufficient rest despite the need to be on 24-hour operational readiness at most airports.

18.5.6 A leader is an individual whose ideas and actions influence the thought and behaviour of others (Liveware vs. Liveware). Through the use of motivation and persuasion, and an understanding of the

goals and desires of the team, the leader becomes an agent of change and influence. Skilled leadership may be needed to understand and handle various operational, training and administrative situations. For instance, personality clashes within a team complicate the task of a leader and can affect both safety and efficiency.

-----

# Appendix 1

## Introduction

This Appendix provides the following general information:

- a) principles of rescue and fire fighting procedures

The purpose is to give rescue and fire fighting personnel some of the essential information needed to permit them to assess the true nature of the specialized problems involved in performing effective aircraft rescue and fire fighting operations. However, as the quantity of flammable liquids and combustible materials aboard an aircraft varies according to the aircraft model and the operations in which it is engaged, this material can provide only representative information. Personal inspections are necessary to appreciate the variations likely to be encountered in aircraft operations at a particular airport.

- b) principal fire hazard zones in aircraft

This include simplified drawing of the principal fire hazard zones on aircraft

- c) detailed information of concern to fire fighting and rescue personnel on representative aircraft.

Information on the characteristics of commonly used aircraft and other relevant information can be found in the link below:

<http://www.icao.int/safety/Pages/Rescue-Fire-Fighting.aspx>

The table in the link above contains useful information for rescue and firefighting such as wingspan, fuselage length and width, overall length and maximum passenger capacity. To obtain further information about each aircraft model, including the crash charts, from their respective manufacturer, click on the corresponding hyperlink under the column “Aircraft Model”.

The websites of the various aircraft manufacturers contain diagrams that provide, inter alia, general information on principles of rescue and firefighting procedures as well as detailed information of concern to rescue and firefighting personnel on representative aircraft commonly used in the market. The purpose is to give rescue and firefighting personnel some of the essential information needed to permit them to assess the true nature of the specialized problems involved in performing effective aircraft rescue and firefighting operations. However, as the quantity of flammable liquids and combustible materials aboard an aircraft varies according to the aircraft model and the operations in which it is engaged, this material can provide only representative information. Personal inspections are necessary to appreciate the variations likely to be encountered in aircraft operations at a particular airport.

A. PRINCIPLES OF RESCUE

These illustrations show the principal points to consider in gaining access to civil transport aircraft. Each aircraft must be examined individually to know how doors and windows may be most easily opened from outside.

1<sup>st</sup>. LOCATE AND TRY TO GAIN ACCESS AT NORMAL DOORS

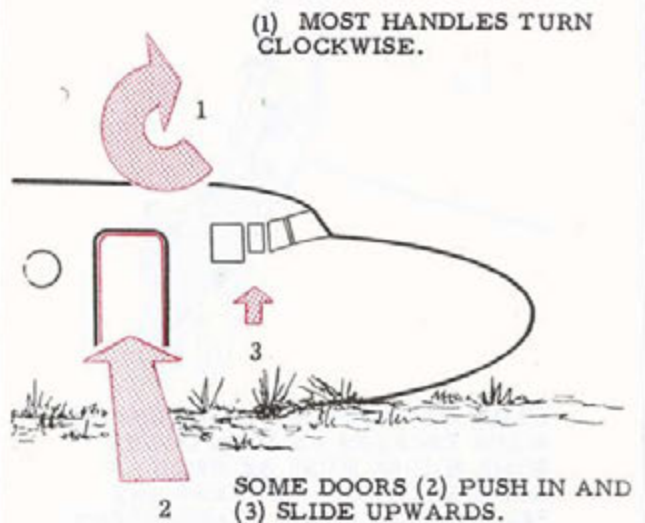
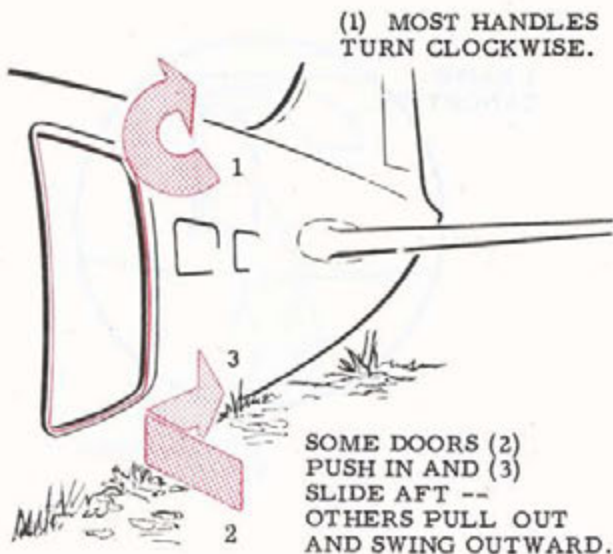
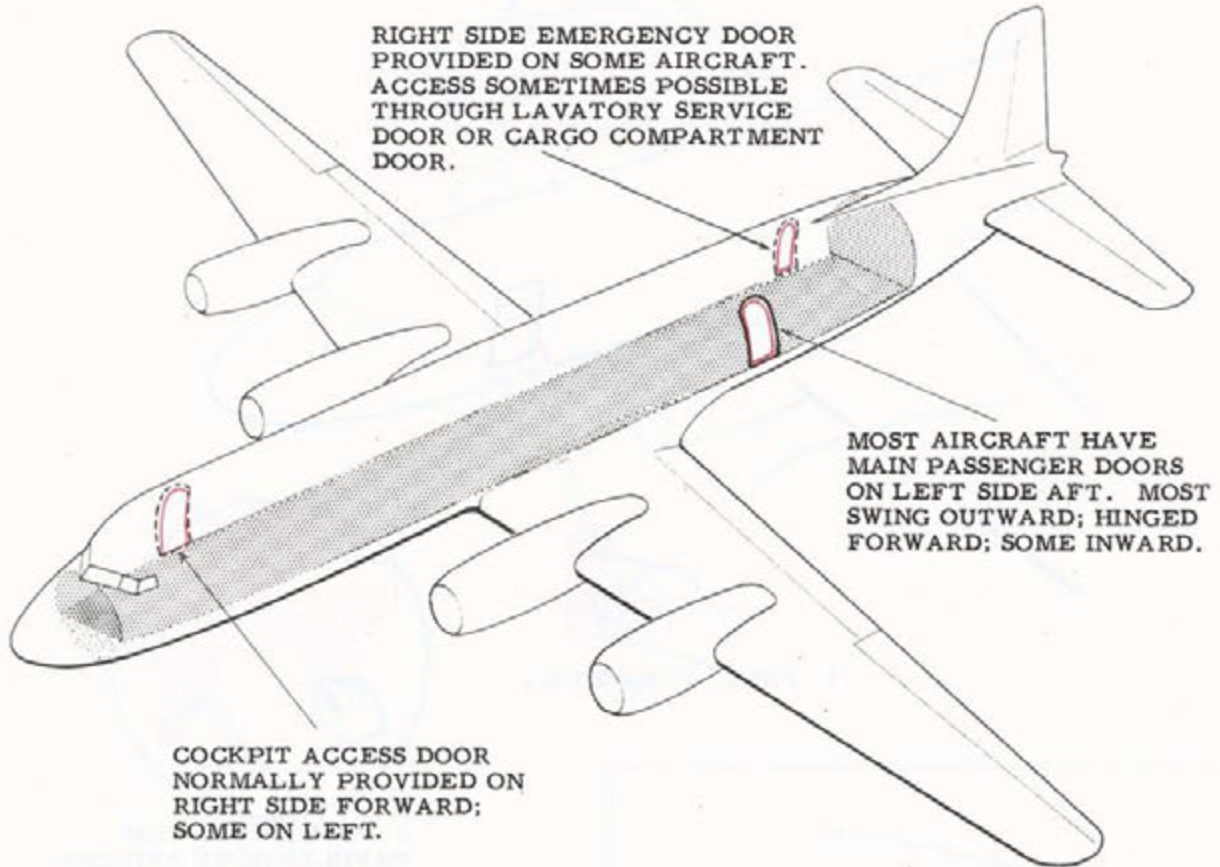

SOME AIRCRAFT HAVE INTEGRAL STAIRS IN NOSE (AS SHOWN) OR AT THE EXTREME AFT END UNDER TAIL.

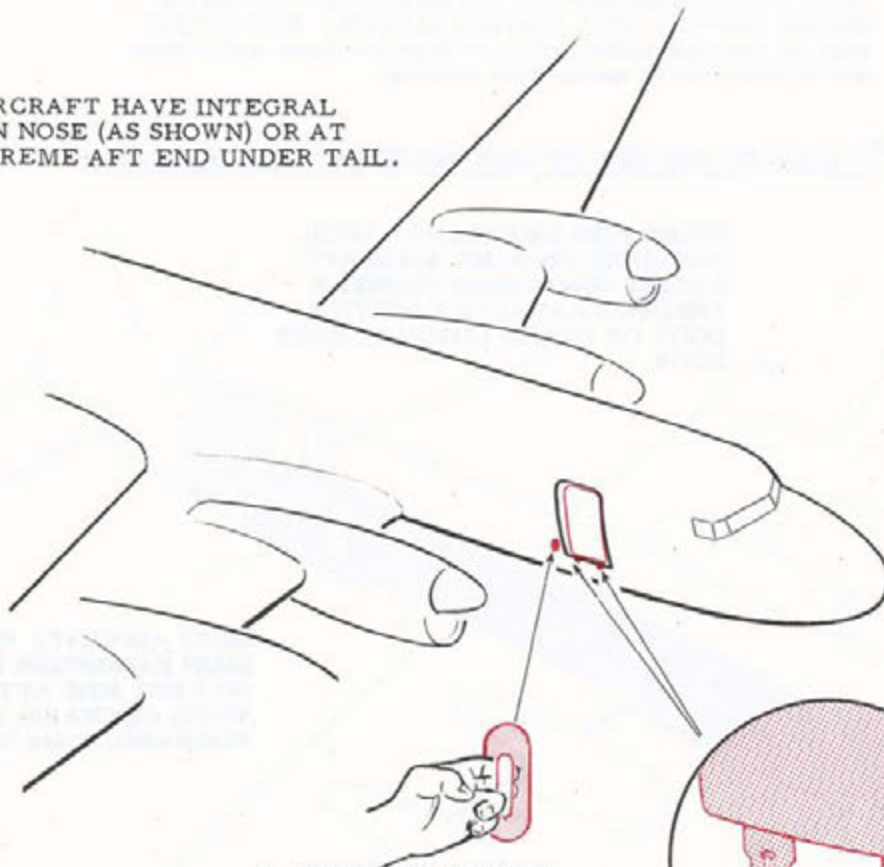

1 PULL "T" HANDLE

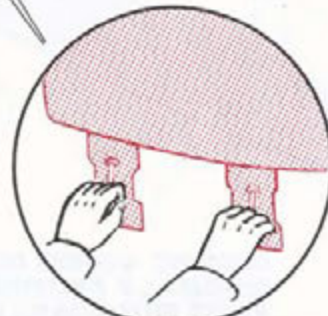

2 PULL TWO LATCH HANDLES DOWN AND OUT.

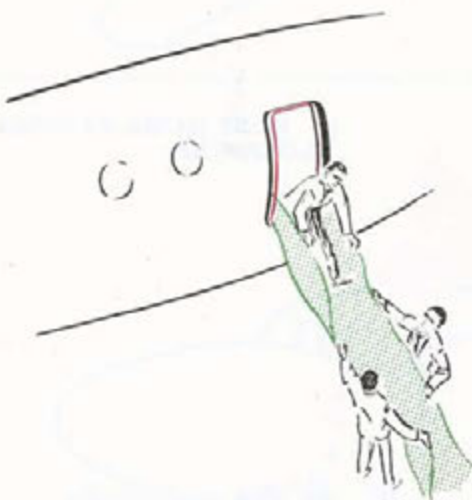

SOME AIRCRAFT HAVE EMERGENCY SLIDE ESCAPES AT MAIN DOORS. SOME SLIDES MUST BE HELD AT GROUND LEVEL -- OTHERS ARE SELF-INFLATABLE. PASSENGERS SHOULD JUMP INTO SLIDE.

3 RAISE CANOPY.

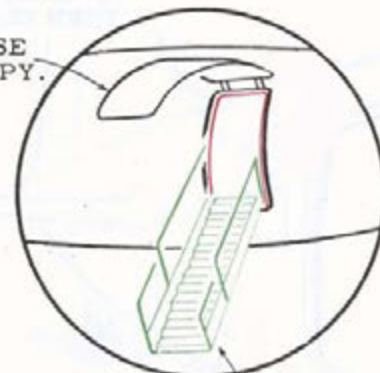

4 PULL DOWN STAIRS.

**2<sup>nd</sup>. LOCATE AND TRY TO OPERATE WINDOW EXITS**

**NOTE**

Emergency window locations vary.  
 Location can be recognized by outline of joint  
 between hatch and fuselage and by marking of  
 release devices similar to those shown.  
 Investigate special features of aircraft.

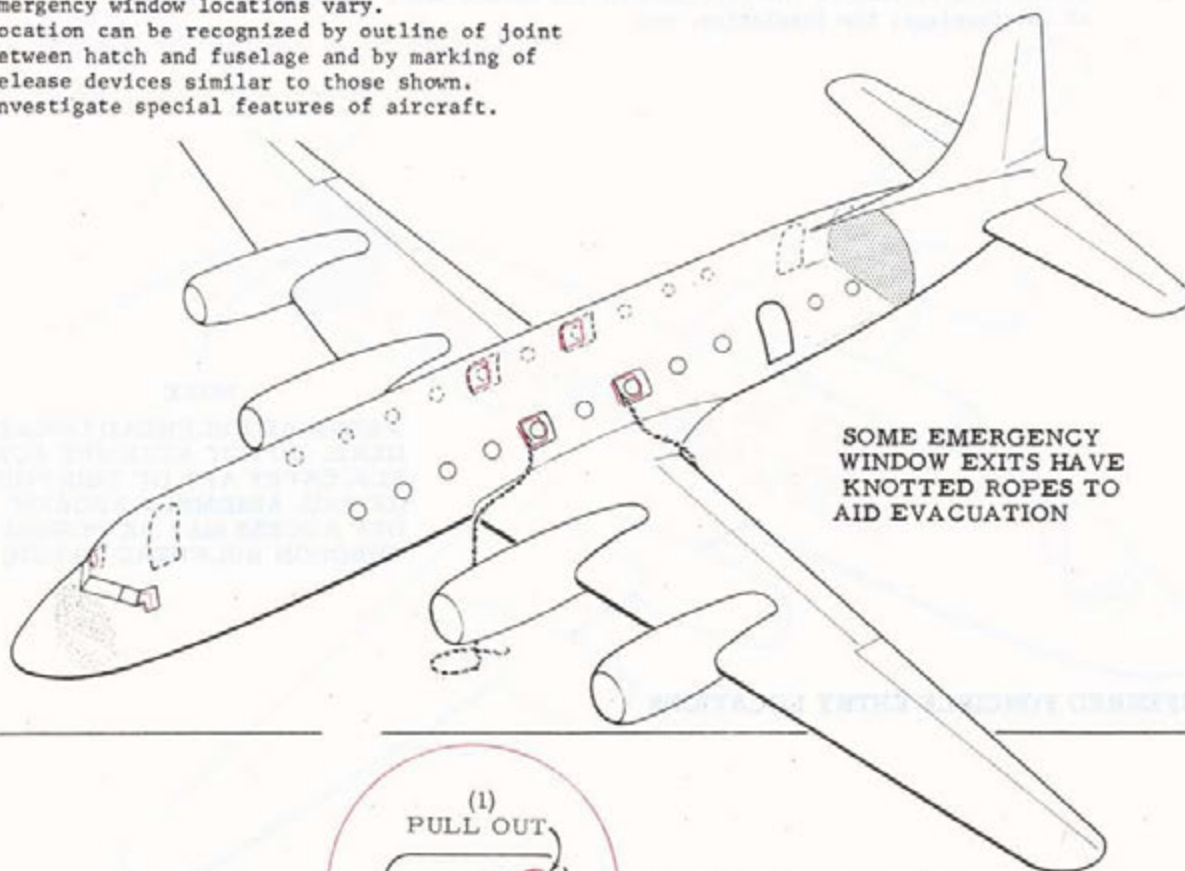

**SOME EMERGENCY WINDOW EXITS HAVE KNOTTED ROPES TO AID EVACUATION**



**SOME EMERGENCY WINDOW EXITS HAVE THIS TYPE RED HANDLE - (1) PULL OUT (2) PULL DOWN AND ROTATE WHILE STILL PULLING.**

**OTHER EMERGENCY WINDOWS OPERATE LIKE THIS**



**EMERGENCY EXIT**  
 SOME WINDOWS HAVE BARS TO LIFT AND PULL - THEN PUSH.

**OR THIS**

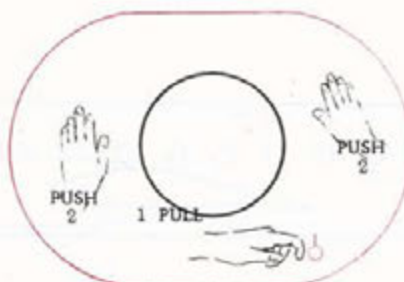

**EMERGENCY EXIT**  
 SOME WINDOWS HAVE RINGS TO PULL - THEN PUSH-IN.

**OR THIS**



**SOME WINDOWS HAVE BUTTONS TO PUSH.**



### 3<sup>rd</sup> AS LAST RESORT MAKE FORCIBLE ENTRY

These illustrations show reciprocating-engine aircraft. Forcible entry locations on modern turbine-powered transport aircraft are most difficult to cut into because of the thickness of the metals used, the extensive framing of the fuselage, the insulation, etc.

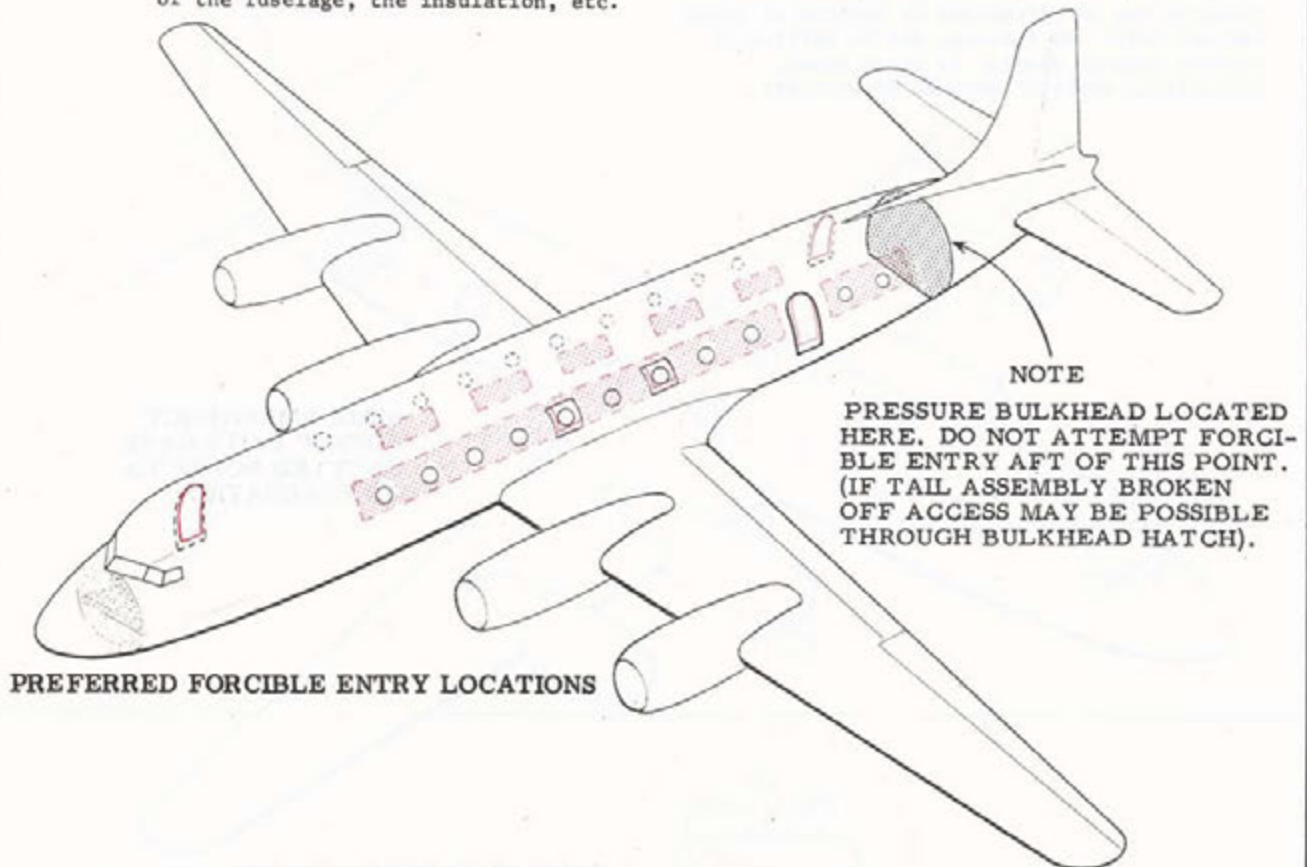

PREFERRED FORCIBLE ENTRY LOCATIONS



1. FORCE NORMAL OR EMERGENCY DOORS OR WINDOWS IF POSSIBLE.



2. SAW OR CUT IN AT OR BETWEEN WINDOWS ABOVE SEAT ARM LEVEL AND BELOW THE HAT RACK OR ON EITHER SIDE OF CENTRE LINE OF TOP FUSELAGE SECTION. SOME AIRCRAFT HAVE BREAK-IN POINTS. REMEMBER WHEN CUTTING IN, OCCUPANTS MAY BE EXPOSED TO INJURY FROM CUTTING TOOLS. OTHER AREAS LIABLE TO BE BLOCKED BY INTERNAL OBSTRUCTIONS.

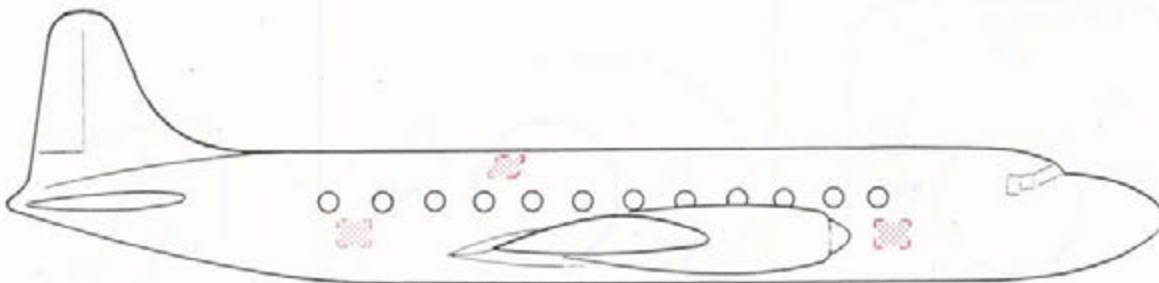

3. SAW OR CUT IN AT BREAK-IN POINTS. THESE POINTS ARE MARKED WITH RED OR YELLOW CORNER MARKINGS, AND IF NECESSARY ARE OUTLINED IN WHITE TO CONTRAST WITH THE BACKGROUND.

### B. PRINCIPAL FIRE HAZARD ZONES IN AIRCRAFT

This is a simplified drawing of the principal fire hazard zones on aircraft.

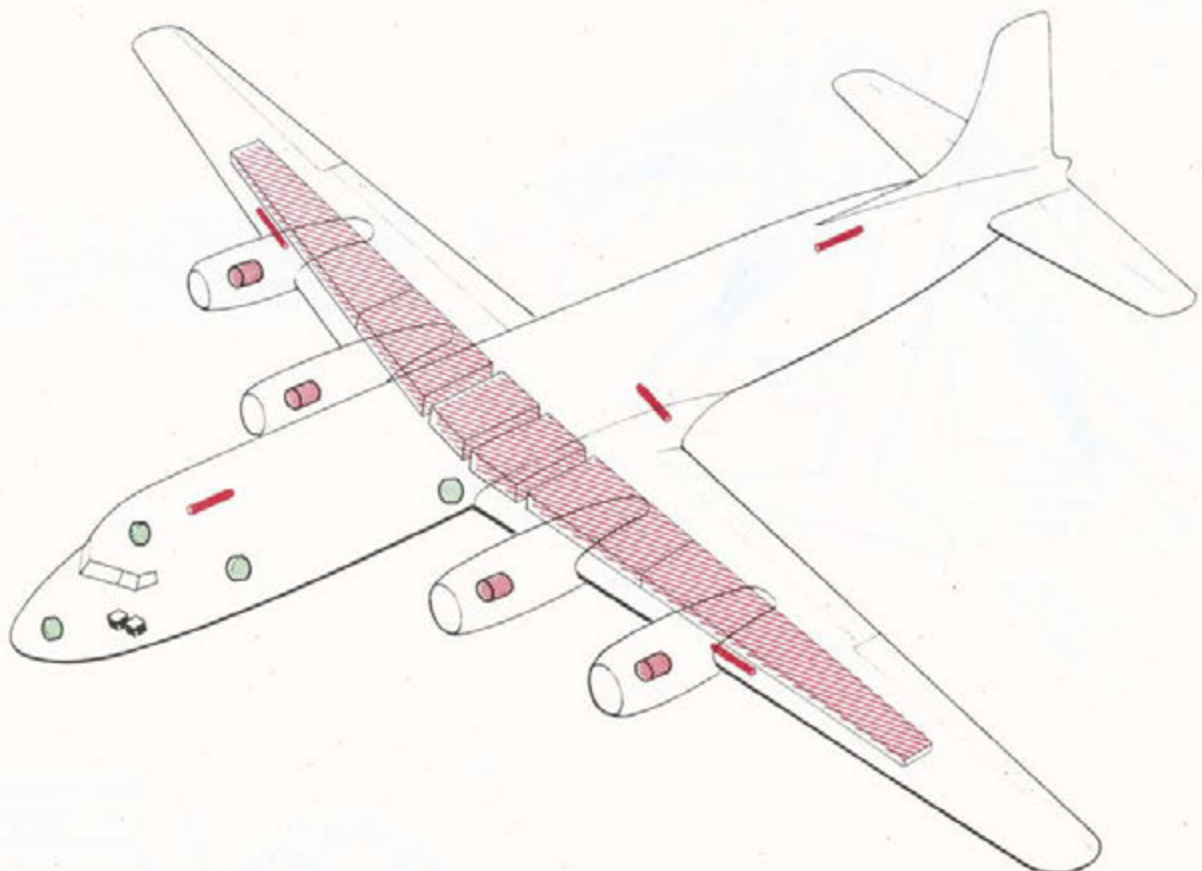

FUEL TANKS NORMALLY IN WINGS - SOME RUN THROUGH FUSELAGE - OTHERS ALL OUTBOARD OF INBOARD ENGINES. FUEL TANKS ARE INTERCONNECTED AND HAVE CROSS-FEED VALVES. TANK VENTS ARE NORMALLY AT TRAILING EDGE OF WING.



OIL TANKS NORMALLY IN NACELLES BEHIND ENGINE FIREWALL - SOME FORWARD OF FIREWALL.



BATTERIES NORMALLY LOCATED FORWARD AS SHOWN AND MARKED ON EXTERIOR - DISCONNECT IF NO FIRE AFTER CRASH. SOME LOCATED IN NOSE WHEEL WELL. QUICK DISCONNECT FITTINGS NORMALLY ARE PROVIDED.



GASOLINE COMBUSTION HEATERS LOCATED IN WINGS, FUSELAGE OR TAIL (RECIPROCATING-ENGINE AIRCRAFT ONLY).



HYDRAULIC FLUID RESERVOIRS LOCATED IN FUSELAGE FORWARD OR NEAR WING ROOT.

## C. PRINCIPLES OF FIRE FIGHTING

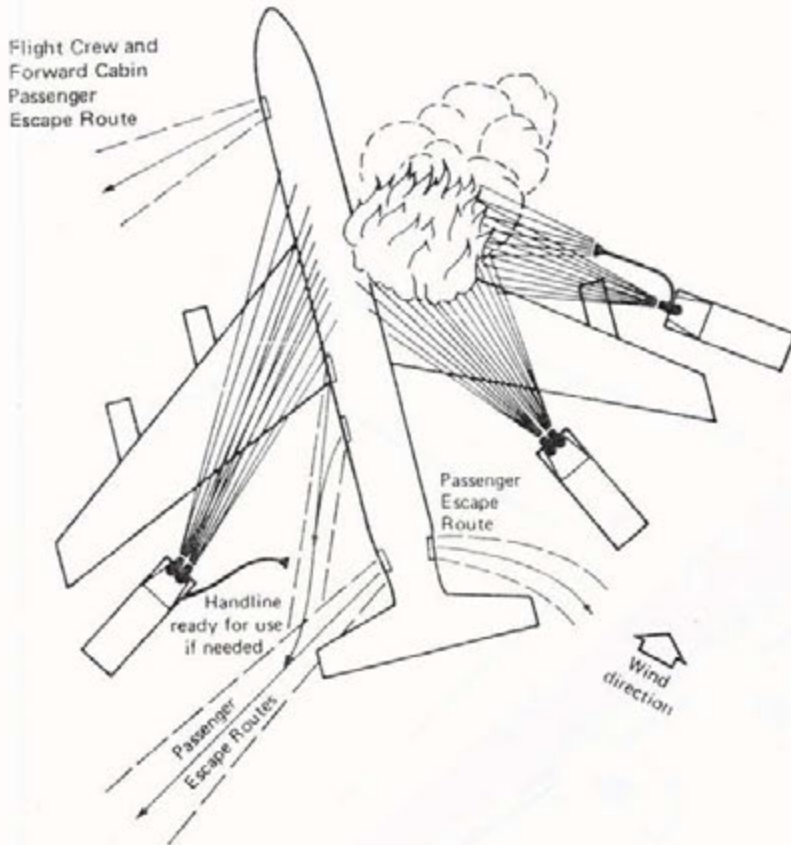

Using three vehicles dispensing foam with fire in wing-root area on one side and a near cross wind. If port engines are still operating at time fire fighting commences, the attack from the port side would have to be shifted forward of the wing.

Using three vehicles with fire involving port inboard engine and integral fuel tank area. Maintaining fuselage integrity is the first principle to allow passenger evacuation.

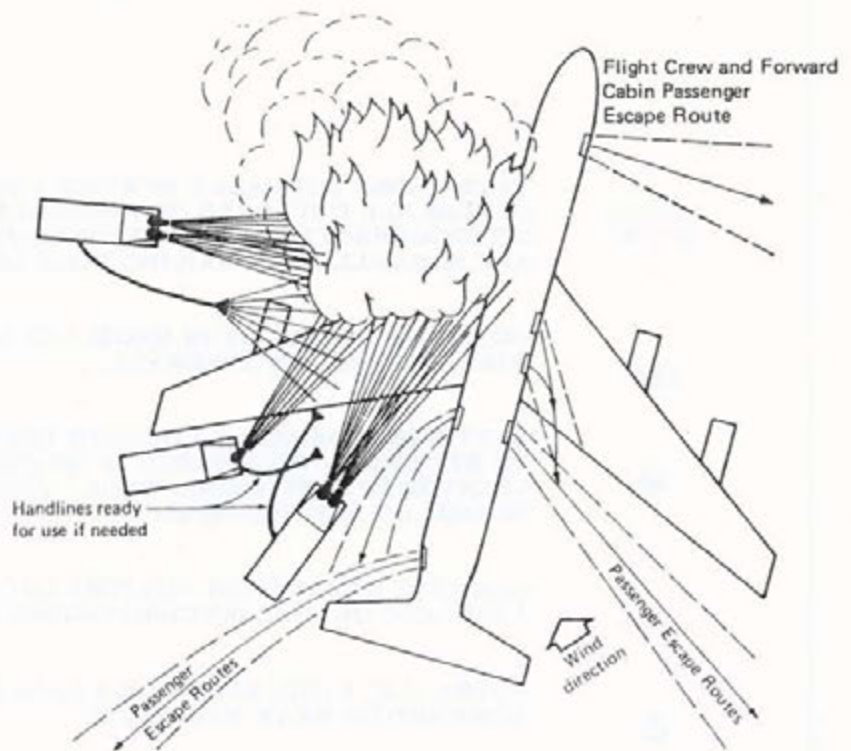

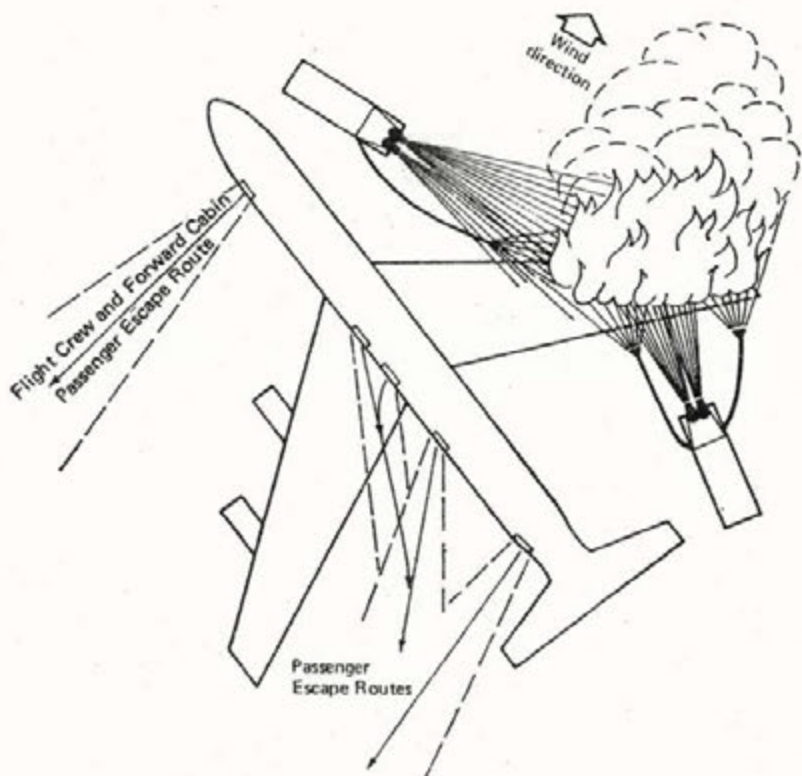

Using two vehicles with fire involving the outboard engine on starboard side. Here the attack is concentrating on controlling the fire and keeping the fuselage shielded from radiant heat and avoiding any direct flame contact which could cause breaching of the fuselage.

Using three vehicles under one of the most adverse conditions where fire involves the entire wing-span of the aircraft. The attack is aimed with the wind and the effort is to keep the fuselage intact while the flight crew and passengers escape via the forward doors.

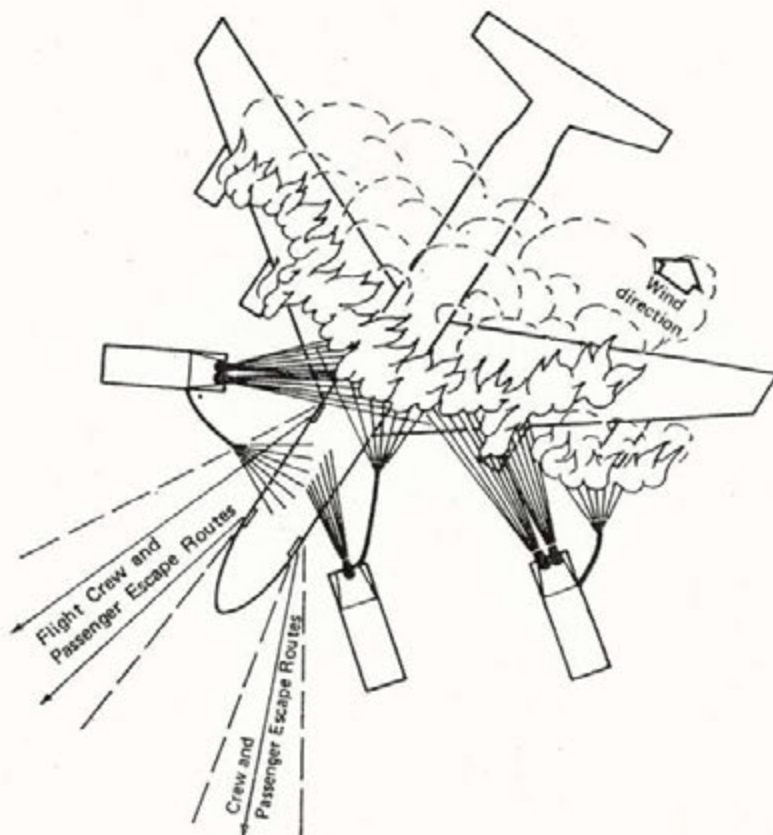

## Appendix 2

### Aeroplane Classification by Airport Category

Non exhaustive list, based on aeroplanes (type, series) using aerodromes in 2013.

Fuselage length and width are given for information. These dimensions may vary depending on models.  
Please refer to type-certificate data-sheet or official manufacturer documentation for exact dimensions if necessary.

Aeroplane	Over-all length (m)	Maximum fuselage width (m)
<b>Airport Category 10</b>	<b><math>76 \leq L &lt; 90</math></b>	<b><math>w \leq 8</math></b>
Airbus A380-800	72.7	7.1
Antonov AN-225	84.0	6.4
Boeing 747-8	76.3	6.5
<b>Airport Category 9</b>	<b><math>61 \leq L &lt; 76</math></b>	<b><math>w \leq 7</math></b>
Airbus A330-300	63.7	5.6
Airbus A340-300	63.7	5.6
Airbus A340-500	67.9	5.6
Airbus A340-600	75.4	5.6
Airbus A350-900	66.8	6.0
Antonov AN-124	69.1	6.4
Boeing 747-100, -200, -300	70.4	6.5
Boeing 747-400	70.7	6.5
Boeing 767-400ER	61.4	5.0
Boeing 777-200	63.7	6.2
Boeing 777-300ER	73.9	6.2
Boeing 787-9	62.8	5.8
Ilyushin IL-96-400, M, T	63.9	6.1
McDonnell Douglas MD 11	61.6	6.0
<b>Airport Category 8</b>	<b><math>49 \leq L &lt; 61</math></b>	<b><math>w \leq 7</math></b>
Airbus A300 B2, B4	53.6	5.6
Airbus A300 B4-600, F4-600	54.1	5.6
Airbus A310	46.7	5.6
Airbus A330-200	59.0	5.6
Airbus A340-200	59.4	5.6
Boeing 747 SP	56.3	6.5
Boeing 757-300	54.4	3.8
Boeing 767-200	48.5	5.0
Boeing 767-300	54.9	5.0
Boeing 787-8	56.7	5.8
Ilyushin IL-62	53.1	3.8
Ilyushin IL-96-300	55.4	6.1
Lockheed L-1011 Tristar	54.4	6.0
McDonnell Douglas DC8 -61, 61F, 63, 63F	57.1	3.7
McDonnell Douglas DC10 Series 10 / Series 40 ( <i>MD 10</i> )	55.6	6.0
McDonnell Douglas DC10 Series 30 ( <i>MD 10</i> )	55.4	6.0

Aeroplane	Over-all length (m)	Maximum fuselage width (m)
	$39 \leq L < 49$	$w \leq 5$
<b>Airport Category 7</b>		
Airbus A321	44.5	4.0
Boeing 707-320, 320B, 320C, 420	46.6	3.8
Boeing 720	41.5	3.8
Boeing 720B	41.7	3.8
Boeing 727-100, 100C	40.6	3.8
Boeing 727-200	46.7	3.8
Boeing 737-800	39.5	3.8
Boeing 737-900ER	42.1	3.8
Boeing 757-200	47.3	3.8
Bombardier CRJ 1000	39.1	2.7
McDonnell Douglas DC8-62, 62F, 72, 72F	48.0	3.8
McDonnell Douglas DC9-50	40.7	3.4
McDonnell Douglas MD 81, 82, 83, 88	45.0	3.4
McDonnell Douglas MD 87	39.8	3.4
McDonnell Douglas MD 90-30	46.5	3.4
Tupolev TU 154	47.9	3.8
Tupolev TU 204-300	40.2	3.8
Tupolev TU 204-100, -120, -214	46.1	3.8

Aeroplane	Over-all length (m)	Maximum fuselage width (m)
	$28 \leq L < 39$	$w \leq 5$
<b>Airport Category 6</b>		
Airbus A318	31.5	4.0
Airbus A319	33.8	4.0
Airbus A320	37.6	4.0
Antonov AN-148	29.1	3.4
Antonov AN-158	34.4	3.4
BAe System BAe 146 -300 / AVRO RJ 100 and RJ 115	31.0	3.6
BAe System BAe 146-200 / AVRO RJ 85	28.6	3.6
Boeing 717	37.8	3.4
Boeing 737-100	28.7	3.8
Boeing 737-200	30.5	3.8
Boeing 737-300	33.4	3.8
Boeing 737-400	36.4	3.8
Boeing 737-500	31.0	3.8
Boeing 737-600	31.2	3.8
Boeing 737-700	33.6	3.8
Bombardier CRJ 700	32.5	2.7
Bombardier CRJ 705, 900	36.4	2.7
Bombardier CS 100	35.0	3.7
Bombardier Q400 / DHC 8-400 ( <i>Dash 8-400</i> )	32.8	2.7
Bombardier Global 5000	29.5	2.7
Bombardier Global Express / Global 6000	30.3	2.7
Embraer 170	29.9	3.0
Embraer 175	31.7	3.0
Embraer 190 / Lineage 1000	36.2	3.0
Embraer 195	38.7	3.0
Embraer ERJ 140	28.5	2.3
Embraer ERJ 145 / Legacy 600, 650	29.9	2.3
Fokker Fellowship F-28, MK 2000, 4000	29.6	3.3
Fokker F100	35.5	3.3
Fokker F70	30.9	3.3
Gulfstream Aerospace Gulfstream VI, G650	30.4	2.7
Gulfstream Aerospace Gulfstream V, G500, G550	29.4	2.4
Ilyushin IL-18	35.9	3.2
Lockheed L 100-20 Hercules	32.3	4.3
Lockheed Electra L-188	31.9	3.5
McDonnell Douglas DC9-10, -20	31.8	3.4
McDonnell Douglas DC9-30	36.4	3.4
Sukhoi Superjet 100-95	29.9	3.4
Tupolev TU-134A	37.1	2.7
Yakovlev Yak-42D	36.4	3.8

Aeroplane	Over-all length (m)	Maximum fuselage width (m)
<b>Airport Category 5</b>	<b><math>24 \leq L &lt; 28</math></b>	<b><math>w \leq 4</math></b>
ATR 72	27.2	2.8
BAe System BAe ATP	26.0	2.5
BAe System BAe 146 -100 / AVRO RJ 70	26.2	3.6
Bombardier CRJ -100, -200 / Challenger 800, 850	26.7	2.7
Bombardier Q300 / DHC 8-300 ( <i>Dash 8-300</i> )	25.7	2.7
Convair 440 – 640	24.8	2.5
De Havilland Canada DHC-7 ( <i>Dash 7</i> )	24.6	2.8
Embraer ERJ 135 / Legacy 600	26.3	2.3
Fokker F 27 <i>Friendship</i> MK -500 / -600	25.1	2.7
Fokker <i>Fellowship</i> F 28, MK -1000 / -3000	27.4	3.3
Fokker F50	25.3	2.7
Gulfstream Aerospace Gulfstream II	24.4	2.4
Gulfstream Aerospace Gulfstream IV / IV SP	26.9	2.4
Gulfstream Aerospace Gulfstream 350 / 450	27.2	2.4
NAMC YS- 11	26.3	2.7
Saab 2000	27.3	2.9
Xi'an AIC MA60	24.7	2.8
<b>Airport Category 4</b>	<b><math>18 \leq L &lt; 24</math></b>	<b><math>w \leq 4</math></b>
Antonov AN-140	22.6	2.5
Antonov AN-24V, Srs II	23.5	2.8
ATR 42	22.7	2.8
BAe System Jetstream 41	19.3	2.0
Bombardier 415 / Canadair CL-415	19.8	2.6
Bombardier Challenger 300	20.9	2.2
Bombardier Challenger 600 / Canadair CL 600/601	20.9	2.5
Bombardier Q200 / DHC 8-100,-200 ( <i>Dash 8</i> )	22.3	2.7
Cessna Citation X ( <i>Model 750</i> )	22.0	2.0
Cessna Sovereign ( <i>Model 680</i> )	19.4	2.0
Dassault Aviation Falcon 2000	20.2	2.4
Dassault Aviation Falcon 50	18.5	1.9
Dassault Aviation Falcon 7X	23.4	2.4
Dassault Aviation Falcon 900	20.2	2.4
Dornier Fairchild 328 / 328 JET	21.3	2.2
Embraer EMB-120 <i>Brasilia</i>	20.0	2.3
Fokker and Fairchild Friendship F-27	23.6	2.7
Grumman Gulfstream I	19.4	1.9
Gulfstream Aerospace Gulfstream G200	19.0	2.3
Gulfstream Aerospace Gulfstream G250	20.3	2.3
<i>Hawker Siddeley HS-748/AVRO 748</i>	20.4	2.7
Raytheon Hawker 4000	21.2	2.2
Saab 340	19.7	2.3
Yakovlev Yak 40	20.4	2.3



Aeroplane	Over-all length (m)	Maximum fuselage width (m)
<b>Airport Category 3</b>		
	<b><math>12 \leq L &lt; 18</math></b>	<b><math>w \leq 3</math></b>
B Ae System Jetstream 31	14.4	2.0
Beechcraft Super King Air (Series 200, 300)	13.3 to 14.2	1.5
Beechcraft 1900 D	17.6	1.5
Beechcraft 99 Airliner	13.6	1.4
Beechcraft King Air (Series 100)	12.2	1.5
Bombardier Learjet Series (23.../...75)	13.2 to 17.9	1.6
Britten-Norman Trislander	15.0	1.2
Cessna 208B Grand Caravan / Super Cargomaster	12.7	1.6
Cessna Citation (except Citation X and Sovereign)	12.3 to 17.0	2.0
Cessna CitationJet (525 Series)	13 to 16.3	1.6
Dassault Aviation Falcon 20	17.2	1.9
De Havilland Canada DHC 3 ( <i>Otter</i> )	12.8	1.6
De Havilland Canada DHC-6 ( <i>Twin Otter</i> )	15.8	1.6
Dornier Do 228-200	16.6	1.5
Embraer EMB 110 P2 Bandeirante	15.1	1.7
Hawker 1000 ( <i>B Ae 125 Series 1000</i> )	16.4	1.9
Hawker 400 ( <i>Beechcraft 400</i> )	14.8	1.7
Hawker 800 / 750 / 900 ( <i>B Ae 125 Series 800</i> )	15.6	1.9
Hawker HS125 Series 3	14.5	1.8
Let Kunovice Let L-410 Turbolet / L-420	14.4	2.1
Piaggio P.180 Avanti	14.4	2.0
Pilatus PC-12	14.4	1.6
Piper PA-42 Cheyenne	13.2	1.3
Short Brothers Short Skyvan SC.7, <del>Srs 3</del>	12.2	2.0
<b>Airport Category 2</b>		
	<b><math>9 \leq L &lt; 12</math></b>	<b><math>w \leq 2</math></b>
Aero Commander 500A	10.7	1.3
Beechcraft Duke B60	10.3	1.3
Beechcraft Baron G58	9.1	1.1
Beechcraft King Air 90	10.8	1.4
Britten Norman Islander BN2	10.9	1.2
Cessna 208A Caravan I / Caravan 675 / Cargomaster	11.5	1.6
Cessna 310, 320	9.7	1.3
De Havilland Canada DHC-2 ( <i>Beaver</i> )	9.2	1.3
De Havilland Dove DH 104	11.9	1.6
Piper Navajo PA-31	9.9	1.3
<b>Airport Category 1</b>		
	<b><math>0 \leq L &lt; 9</math></b>	<b><math>w \leq 2</math></b>
Beechcraft Baron Model 55	8.8	1.1
Beechcraft Bonanza 35	7.7	1.1
Beechcraft Bonanza G36	8.4	1.1
Cessna 150	7.0	1.1
Cessna 172 Skyhawk	8.3	1.1
Cessna 182 Skylane	8.9	1.1
Cessna 206 / 206H	8.6	1.1
Cessna 210H Centurion	8.6	1.1
Piper PA-18 150 Super cub	6.9	1.1
Piper PA-28 Cherokee	7.2	1.1
Piper PA-32 Cherokee Six	8.4	1.1
Robin DR 400	7.0	1.1

# Appendix 3

## UNI 86 Foam Nozzle

Note.— Drawing of the UNI 86 Foam Nozzle was prepared for the International Organization for Standardization (ISO) for inclusion in IS 7203 in due course.

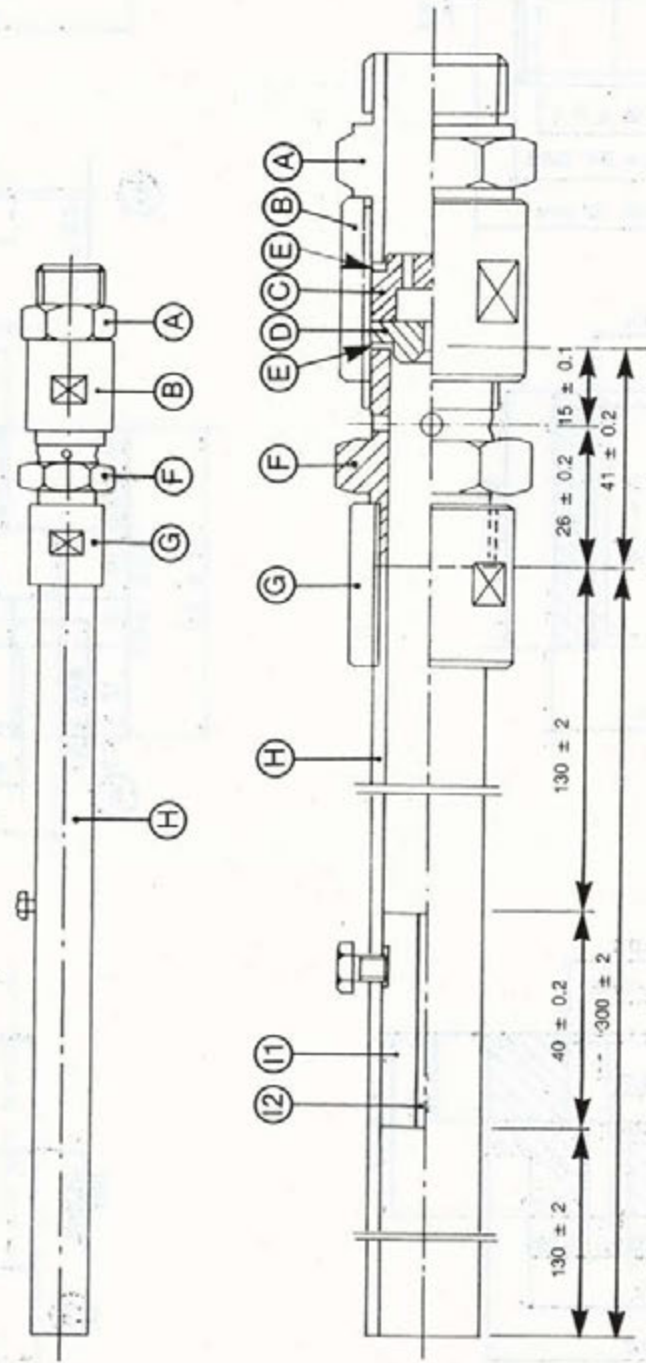

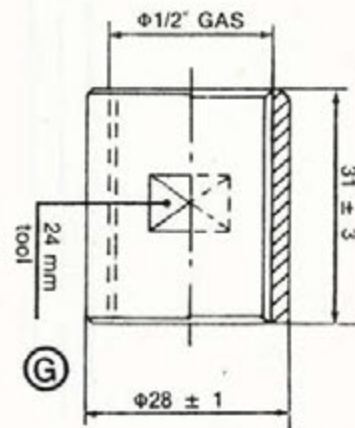
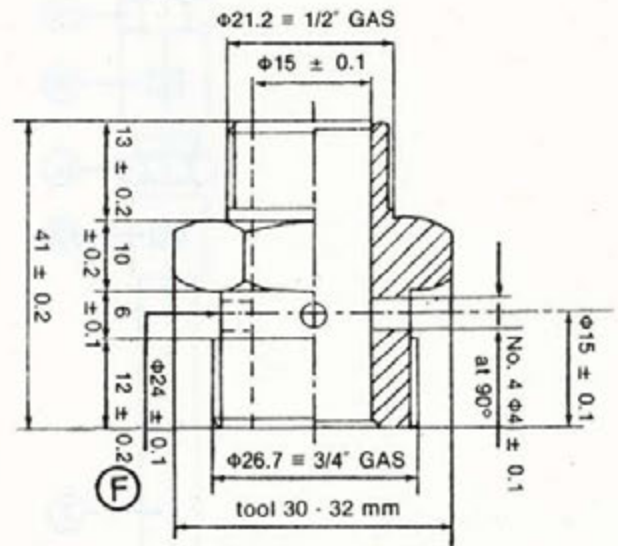
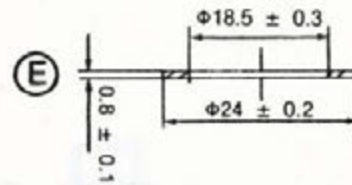
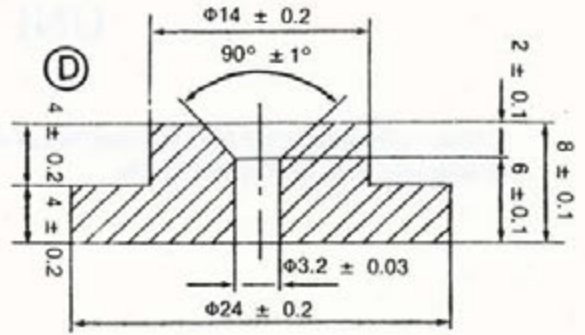
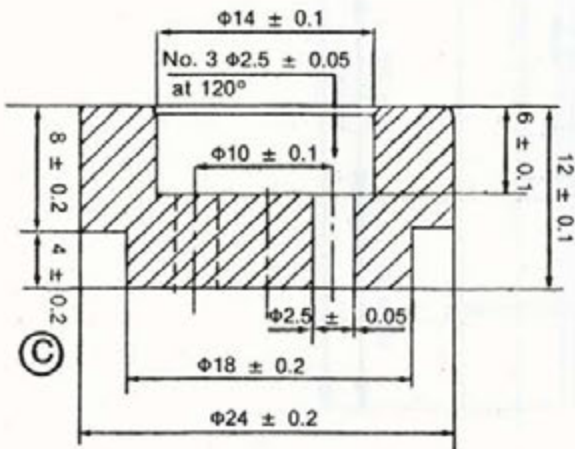
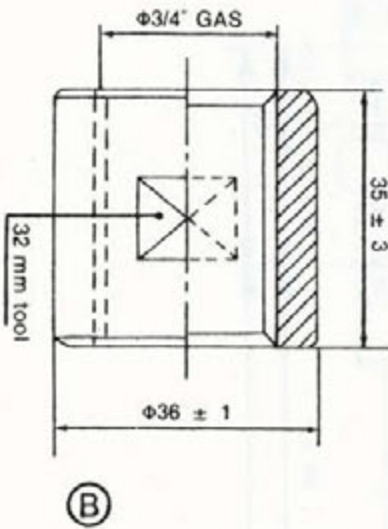
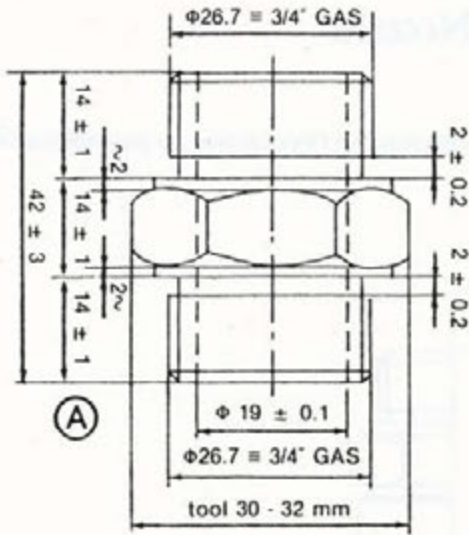

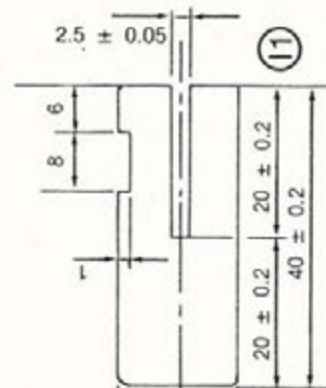
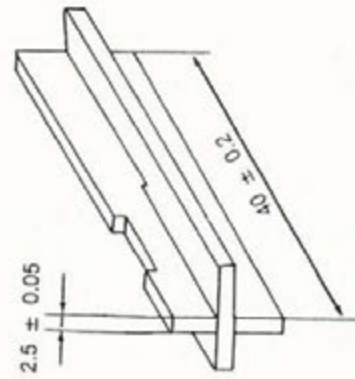
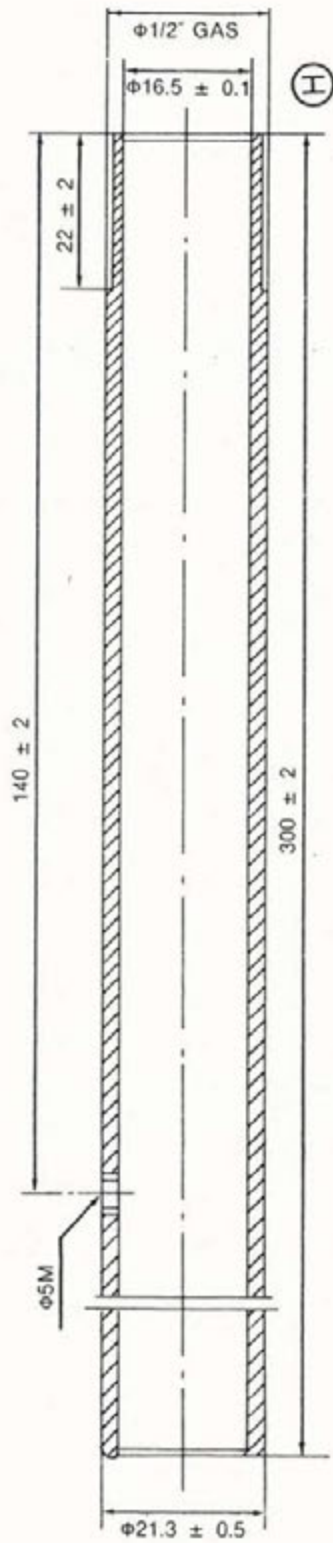

$16.4 \times 2.5$   
 $\pm 0.1$

12

